



SPLIT-TYPE AIR CONDITIONERS INSTALLATION MANUAL

SG79Y952H03

Model names are indicated in 1-3.

When installing multi units, refer to the installation manual of the multi unit for outdoor unit installation.

Required Tools for Installation

Phillips screwdriver	5/32 in. (4 mm) hexagonal wrench
Level	Flare tool for R410A
Scale	Gauge manifold for R410A
Utility knife or scissors	Vacuum pump for R410A
2-9/16 in. (65 mm) hole saw	Charge hose for R410A
Torque wrench	Pipe cutter with reamer
Wrench (or spanner)	

1. BEFORE INSTALLATION

1-1. THE FOLLOWING SHOULD ALWAYS BE OBSERVED FOR SAFETY

- Be sure to read "THE FOLLOWING SHOULD ALWAYS BE OBSERVED FOR SAFETY" before installing the air conditioner.
- Be sure to observe the warnings and cautions specified here as they include important items related to safety.
- After reading this manual, be sure to keep it together with the OPERATING INSTRUCTIONS for future reference.
- Please report to your supply authority or obtain their consent before connecting this equipment to the power supply system.

⚠ WARNING (Could lead to death, serious injury, etc.)

■ Do not install the unit by yourself (user).

Incomplete installation could cause fire or electric shock, injury due to the unit falling, or leakage of water. Consult the dealer from whom you purchased the unit or a qualified installer.

■ Perform the installation securely referring to the installation manual.

Incomplete installation could cause fire or electric shock, injury due to the unit falling, or leakage of water.

■ Install the unit securely in a place which can bear the weight of the unit.

If the installation location cannot bear the weight of the unit, the unit could fall causing injury.

■ Perform electrical work according to the installation manual and be sure to use an exclusive circuit. Do not connect other electrical appliances to the circuit.

If the capacity of the power circuit is insufficient or there is incomplete electrical work, it could result in a fire or an electric shock.

■ Ground the unit correctly.

Do not connect the ground to a gas pipe, water pipe, lightning rod or telephone ground. Defective grounding could cause electric shock.

■ Do not damage the wires by applying excessive pressure with parts or screws.

Damaged wires could cause fire.

■ Be sure to cut off the main power in case of setting up the indoor P.C. board or wiring works.

Failure to do so could cause electric shock.

■ Use the specified wires to connect the indoor and outdoor units securely and attach the wires firmly to the terminal block connecting sections so the stress of the wires is not applied to the sections.

Incomplete connecting and securing could cause fire.

■ Do not install the unit in a place where inflammable gas may leak.

If gas leaks and accumulates in the area around the unit, it could cause an explosion.

■ Do not use intermediate connection of the power cord or the extension cord and do not connect many devices to one AC outlet.

It could cause a fire or an electric shock due to defective contact, defective insulation, exceeding the permissible current, etc.

■ Be sure to use the parts provided or specified parts for the installation work.

The use of defective parts could cause an injury or leakage of water due to a fire, an electric shock, the unit falling, etc.

■ When plugging the power supply plug into the outlet, make sure that there is no dust, clogging, or loose parts in both the outlet and the plug. Make sure that the power supply plug is pushed completely into the outlet.

If there is dust, clogging, or loose parts on the power supply plug or the outlet, it could cause electric shock or fire. If loose parts are found on the power supply plug, replace it.

■ Attach the electrical cover to the indoor unit and the service panel to the outdoor unit securely.

If the electrical cover of the indoor unit and/or the service panel of the outdoor unit are not attached securely, it could result in a fire or an electric shock due to dust, water, etc.

■ When installing or relocating the unit, make sure that no substance other than the specified refrigerant (R410A) enters the refrigerant circuit.

Any presence of foreign substance such as air can cause abnormal pressure rise or an explosion.

■ Do not discharge the refrigerant into the atmosphere. If refrigerant leaks during installation, ventilate the room.

If refrigerant comes in contact with a fire, harmful gas could be generated.

■ Check that the refrigerant gas does not leak after installation has been completed.

If refrigerant gas leaks indoors, and comes into contact with the flame of a fan heater, space heater, stove, etc., harmful substances will be generated.

■ Use appropriate tools and piping materials for installation.

The pressure of R410A is 1.6 times more than R22. Not using appropriate tools or materials and incomplete installation could cause the pipes to burst or injury.

■ When pumping down the refrigerant, stop the compressor before disconnecting the refrigerant pipes.

If the refrigerant pipes are disconnected while the compressor is running and the stop valve is open, air could be drawn in and the pressure in the refrigeration cycle could become abnormally high. This could cause the pipes to burst or injury.

■ When installing the unit, securely connect the refrigerant pipes before starting the compressor.

If the compressor is started before the refrigerant pipes are connected and when the stop valve is open, air could be drawn in and the pressure in the refrigeration cycle could become abnormally high. This could cause the pipes to burst or injury.

■ Fasten a flare nut with a torque wrench as specified in this manual.

If fastened too tight, a flare nut may break after a long period and cause refrigerant leakage.

■ The unit shall be installed in accordance with national wiring regulations.

⚠ CAUTION (Could lead to serious injury in particular environments when operated incorrectly.)

■ Install a Ground Fault Interrupt (GFI) circuit breaker depending on the installation place.

If the Ground Fault Interrupt (GFI) circuit breaker is not installed, it could cause electric shock.

■ Perform the drainage/piping work securely according to the installation manual.

If there is defect in the drainage/piping work, water could drop from the unit, soaking and damaging household goods.

■ Do not touch the air inlet or the aluminum fins of the outdoor unit.

This could cause injury.

■ Do not install the outdoor unit where small animals may live.

If small animals enter and touch the electric parts inside the unit, it could cause a malfunction, smoke emission, or fire. Also, advise user to keep the area around the unit clean.

1-2. SELECTING THE INSTALLATION LOCATION

INDOOR UNIT

- Where airflow is not blocked.
- Where cool air spreads over the entire room.
- Rigid wall without vibration.
- Where it is not exposed to direct sunshine.
- Where easily drained.
- At a distance 3 ft. (1 m) or more away from your TV and radio. Operation of the air conditioner may interfere with radio or TV reception. An amplifier may be required for the affected device.
- In a place as far away as possible from fluorescent and incandescent lights (so the infrared remote control can operate the air conditioner normally).
- Where the air filter can be removed and replaced easily.

Note:

Install indoor unit at a high position on the wall where air can distribute over the entire room.

REMOTE CONTROLLER

- Where it is easy to operate and easily visible.
- Where children cannot touch it.
- Select a position about 4 ft. (1.2 m) above the floor and check that signals from the remote controller are surely received by the indoor unit from that position ('beep' or 'beep beep' receiving tone sounds). After that, attach remote controller holder to a pillar or wall and install wireless remote controller.

Note:

In rooms where inverter type fluorescent lamps are used, the signal from the wireless remote controller may not be received.

OUTDOOR UNIT

- Where it is not exposed to strong wind.
- Where airflow is good and dustless.
- Where neighbours are not annoyed by operation sound or hot air.
- Where rigid wall or support is available to prevent the increase of operation sound or vibration.
- Where there is no risk of combustible gas leakage.
- When installing the unit at a high level, be sure to secure the unit legs.
- Where it is at least 10 ft. (3 m) away from the antenna of TV set or radio. Operation of the air conditioner may interfere with radio or TV reception in areas where reception is weak. An amplifier may be required for the affected device.
- Install the unit horizontally.
- Please install it in an area not affected by snowfall or blowing snow. In areas with heavy snow, please install a canopy, a pedestal and/or some baffle boards.

Note:

- It is advisable to make a piping loop near outdoor unit so as to reduce vibration transmitted from there.
- For increased efficiency, install the outdoor unit in a location where continuous direct sunlight or excessive water can be avoided as much as possible.

Note:

When operating the air conditioner in low outside temperature, be sure to follow the instructions described below.

- Never install the outdoor unit in a place where its air inlet/outlet side may be exposed directly to wind.
- To prevent exposure to wind, install the outdoor unit with its air inlet side facing the wall.
- To prevent exposure to wind, it is recommended to install a baffle board on the air outlet side of the outdoor unit.

Avoid the following places for installation where air conditioner trouble is liable to occur.

- Where flammable gas could leak.
- Where there is much machine oil.
- Salty places such as the seaside.
- Where sulfide gas is generated such as a hot spring.
- Where there is high-frequency or wireless equipment.

1-3. SPECIFICATIONS

1-3-1. POWER SUPPLY AND INDOOR/OUTDOOR WIRE CONNECTION

- Power should be taken from an exclusive branched circuit.
- Wiring work should be based on applicable technical standards.
- Wiring connections should be made following the diagram.
- Screws should be tightened so they will not loosen.

Connecting wires and connecting ground wire

- Use solid conductor AWG14 or stranded conductor AWG14.
- Use double insulated copper wire with 600V insulation.
- Use copper conductors only.

* Follow local electrical code.

Power supply cable and ground wire

- Use solid or stranded conductor AWG14.
- Use copper conductors only.

* Follow local electrical code.

Note:

When the indoor unit is powered from the outdoor unit, a disconnect switch needs to be installed to power supply circuit (between indoor and outdoor unit) depending on local code.

1-3-2. REFRIGERANT PIPES

- Ensure that the 2 refrigerant pipes are insulated to prevent condensation.
- Refrigerant pipe bending radius must be 4 in. (100 mm) or more.

CAUTION

Be sure to use the insulation of specified thickness. Excessive thickness may cause incorrect installation of the indoor unit and lack of thickness may cause dew drippage.

- This unit has flared connections on both indoor and outdoor sides.
- Remove the outdoor units valve cover, then connect the pipe.
- Refrigerant pipes are used to connect the indoor and outdoor units.
- Be careful not to crush or bend the pipe in pipe bending.

- Refrigerant adjustment... If pipe length exceeds 25 ft. (7m), additional refrigerant (R410A) charge is required.

(The outdoor unit is charged with refrigerant for pipe length up to 25 ft. [7 m])

Electrical specifications

MODEL	MSZ-A09/12NA	MSZ-A15/17NA MSY-A15/17NA	MS-A09WA	MS-A12WA
INDOOR UNIT				
Power supply (V, PHASE, Hz)	208/230, 1, 60		115, 1, 60	
Min. Circuit Ampacity	1.0	1.0	1.2	1.2
Fan motor (F.L.A.)	0.76		0.95	
OUTDOOR UNIT				
Power supply (V, PHASE, Hz)	208/230, 1, 60		115, 1, 60	
Max. Fuse size (time delay) (A)	15	15	15	20
Min. Circuit Ampacity	12	14	14	16
Fan motor (F.L.A.)	0.52	0.52	0.63	0.926
Compressor	(R.L.A)	7.8	10.1	9.30
	(L.R.A)	9.2	12	47
Control voltage	Indoor unit - Remote controller: (Wireless) Indoor unit - Outdoor unit: DC12-24V (Polar)		Indoor unit - Remote controller: (Wireless) Indoor unit - Outdoor unit: AC115V	

Pipe	Outside diameter	Minimum wall thickness	Insulation thickness	Insulation material
For liquid	1/4 (6.35)	0.0315 (0.8)	5/16 (8)	Heat resisting foam plastic 0.045 Specific gravity
For gas	MSZ-A09/12NA MS-A09WA	3/8 (9.52)	0.0315 (0.8)	
	MSZ-A15/17NA MSY-A15/17NA MS-A12WA	1/2 (12.7)	0.0315 (0.8)	

Limits	MSZ-A09/12/15/17NA MSY-A15/17NA	MS-A09/12WA
Pipe length	65ft. (20 m) max.	65ft. (20 m) max.
Height difference	40 ft. (12 m) max.	35 ft. (10 m) max.
No. of bends	10 max.	10 max.

Pipe length	Up to 25 ft. (7m)	No additional charge is required.
	Exceeding 25 ft. (7m)	Additional charge is required. (Refer to the table below.)
Refrigerant to be added	MSZ-A09/12/15/17NA MSY-A15/17NA	1.62 oz each 5 ft. (30g/m)
	MS-A09/12WA	1.08 oz. each 5 ft. (20g/m)

1-4. INSTALLATION DIAGRAM

ACCESSORIES

Check the following parts before installation.
<Indoor unit>

(1)	Installation plate	1
(2)	Installation plate fixing screw 4 × 25 mm	5
(3)	Remote controller holder	1
(4)	Fixing screw for (3) 3.5 × 16 mm (Black)	2
(5)	Battery (AAA) for (6)	2
(6)	Wireless remote controller	1
(7)	Felt tape (For left or left-rear piping)	1
(8)	Air cleaning filter	1

PARTS TO BE PROVIDED AT YOUR SITE

(A)	Indoor/outdoor unit connecting wire*	1
(B)	Extension pipe	1
(C)	Wall hole sleeve	1
(D)	Wall hole cover	1
(E)	Pipe fixing band	2 to 5
(F)	Fixing screw for (E) 4 × 20 mm	2 to 5
(G)	Piping tape	1
(H)	Putty	1
(I)	Drain hose (or soft PVC hose, 19/32 in. [15 mm] inner dia. or hard PVC pipe VP16)	2 to 5
(J)	Refrigeration oil	1
(K)	Power supply cord	1

* Note:

Place indoor/outdoor unit connecting wire (A) and power supply cord (K) at least 3 ft. (1 m) away from the TV antenna wire.

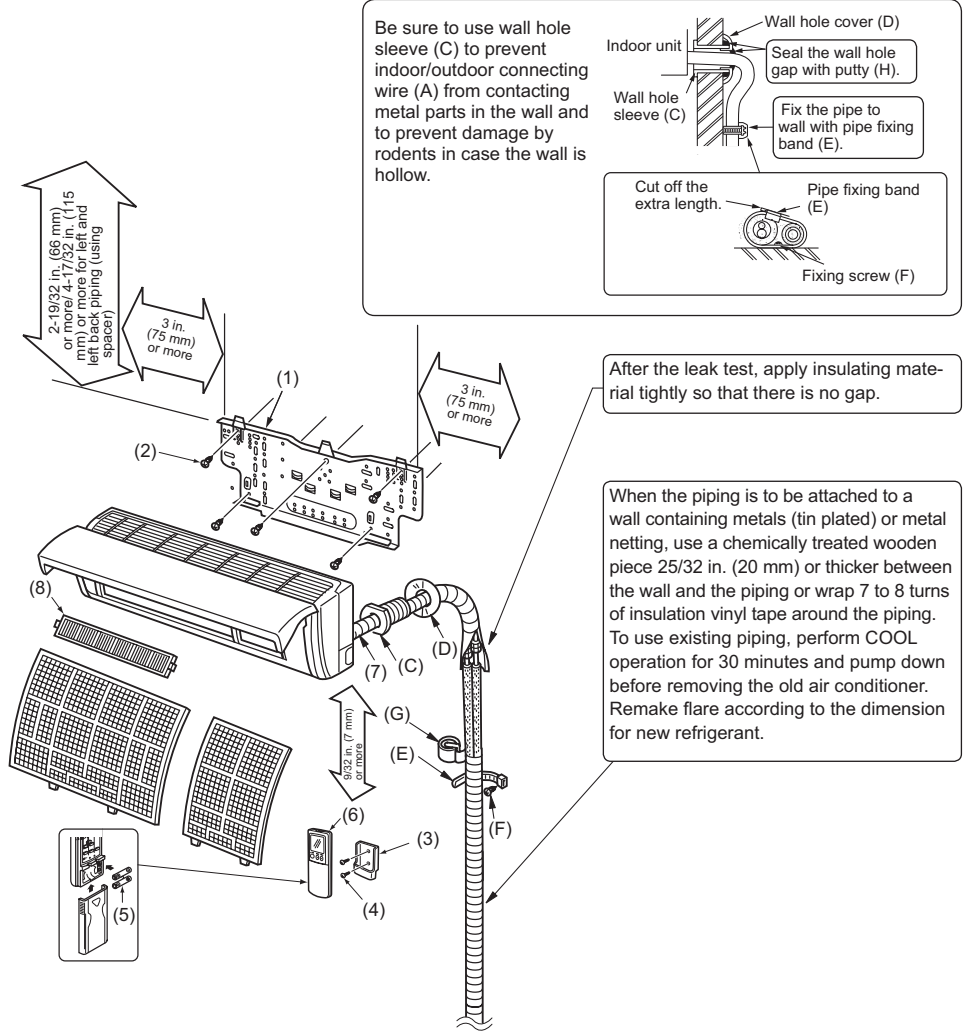

MU-A09WA MUY-A15/17NA MUZ-A09/12/15/17NA

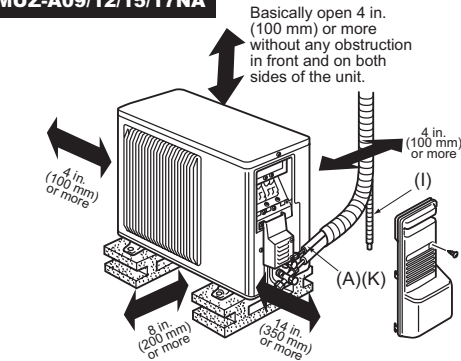

Open two sides of left, right, or rear side.

Unit: inch

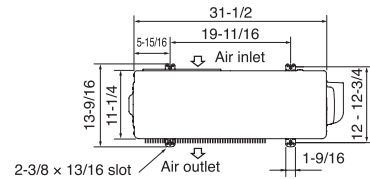

MU-A12WA

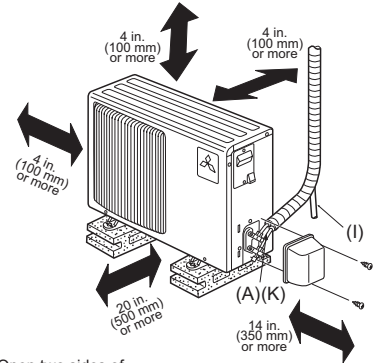

Open two sides of left, right, or rear side.

Unit: inch

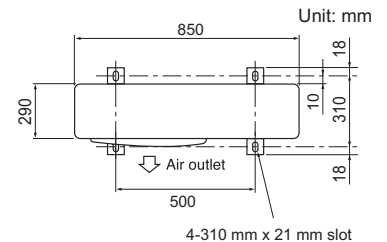
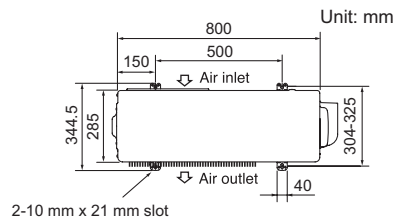
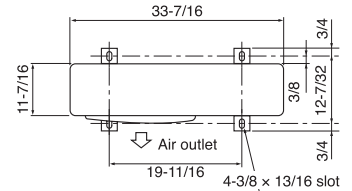

Units should be installed by licensed contractor according to local code requirements.

2. INDOOR UNIT INSTALLATION

2-1. FIXING OF INSTALLATION PLATE

- Find a structural material (such as a stud) in the wall and fix installation plate (1) horizontally with fixing screws (2).
- To prevent installation plate (1) from vibrating, be sure to install the fixing screws in the holes indicated in the illustration. For added support, fixing screws may also be installed in other holes.
- When bolts recessed in the concrete wall are to be utilized, secure installation plate (1) using 7/16 in. x 13/16 in. x 7/16 in. x 1 in. (11 mm x 20 mm x 11 mm x 26 mm) oval hole (17-3/4 in. [450 mm] pitch).
- If the recessed bolt is too long, change it for a shorter one available in the market.

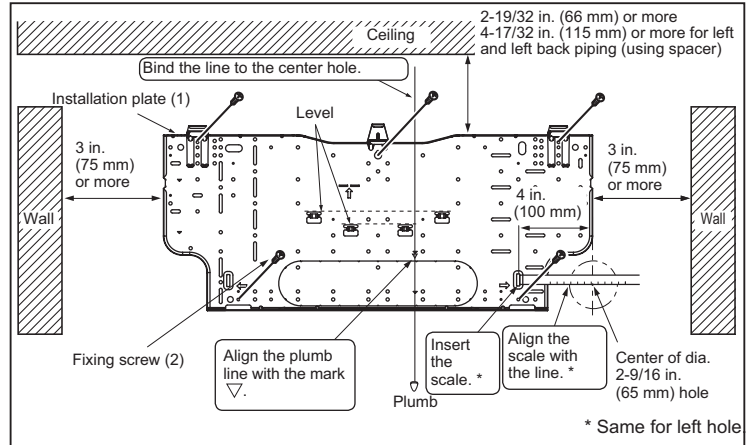

2-2. WALL HOLE DRILLING

- Determine the wall hole position.
- Drill a dia. 2-9/16 in. (65 mm) hole. The outdoor side should be 6/32 to 9/32 in. (5 to 7 mm) lower than the indoor side.
- Insert wall hole sleeve (C).

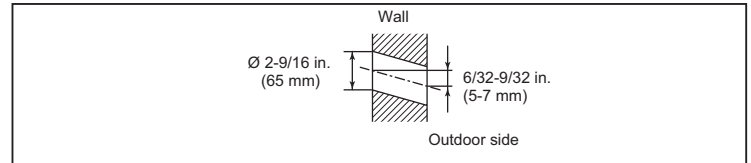

2-3. CONNECTING WIRES FOR INDOOR UNIT

Note:

When the indoor unit is powered from the outdoor unit, a disconnect switch needs to be installed to power supply circuit (between indoor and outdoor unit) depending on local code.

- Remove the front panel. (Refer to 5-1.)
- Hook the upper part of the indoor unit on the installation plate.
- Remove corner box and conduit cover.
- Fix conduit pipe (for rear piping) / elbow joint (for right, left, or downward piping) to conduit cover with lock nut. The thread part of installed conduit pipe / elbow joint appearing inside should be less than 3/8 in. (10 mm). (Fig. 1) Elbow joint should appear less than 1-3/16 in. (30 mm) outside. (Fig. 2)
- Process the end of ground wire (Fig. 3). Connect it to the ground terminal of electrical parts box.
- Process the end of indoor/outdoor unit connecting wire (A) (Fig. 3). Fix it to terminal block. Be careful not to make mis-wiring. Fix the wire to the terminal block securely so that no part of its core is appeared, and no external force is conveyed to the connecting section of the terminal block.
- Firmly tighten the terminal screws to prevent them from loosening. After tightening, pull the wires lightly to confirm that they do not move.
- Secure indoor/outdoor unit connecting wire (A) and the ground wire with conduit cover. Never fail to hook the claw of the conduit cover to the electrical box. Attach the conduit cover securely. (Fig. 4)
- According to the piping direction, cut off the shaded part of the left side of box (Fig. 5) or corner box (Fig.6). Reinstall corner box and front panel.

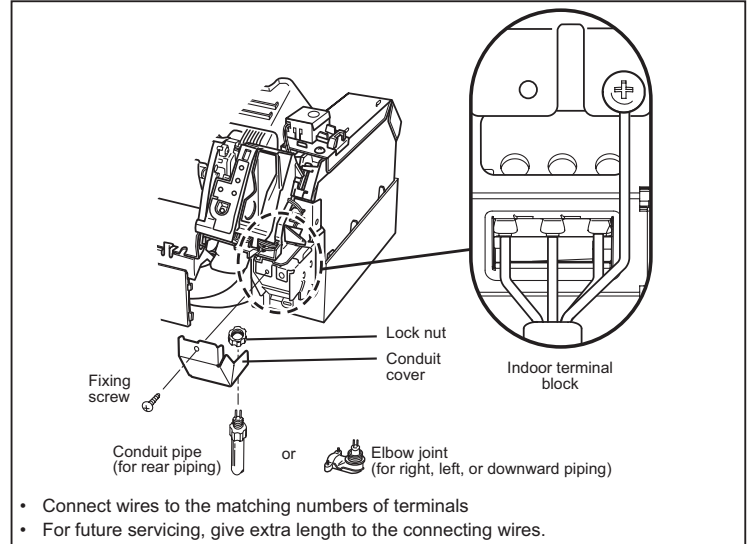

MS-A09/A12WA

Remark:

* A disconnect switch should be required.

** Use a ring tongue terminal in order to connect a ground wire to terminal.

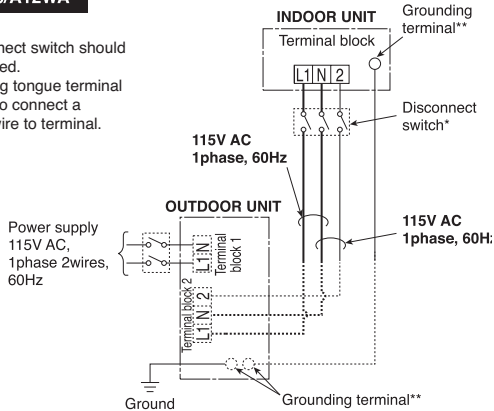

MSY-A15/A17NA MSZ-A09/A12/A15/A17NA

Remark

* A disconnect switch should be required.

** Use a ring tongue terminal in order to connect a ground wire to terminal.

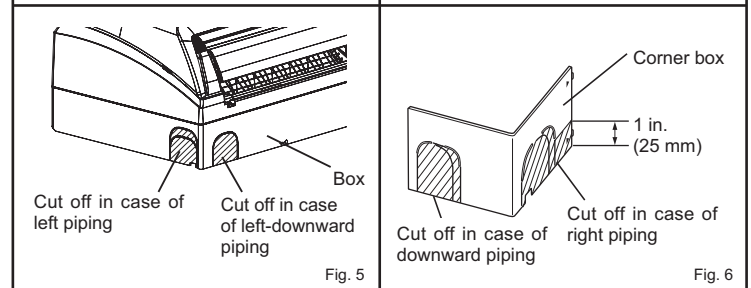
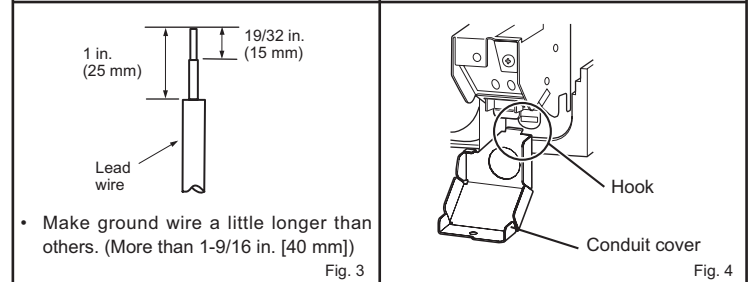
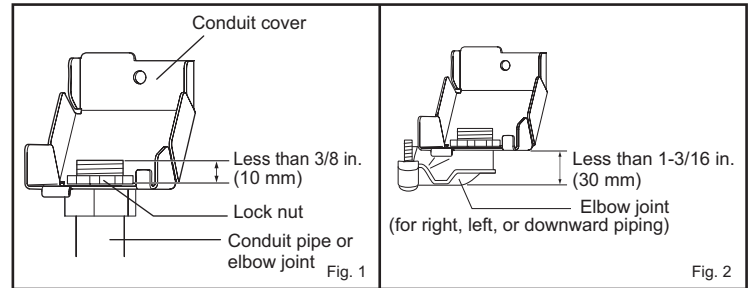
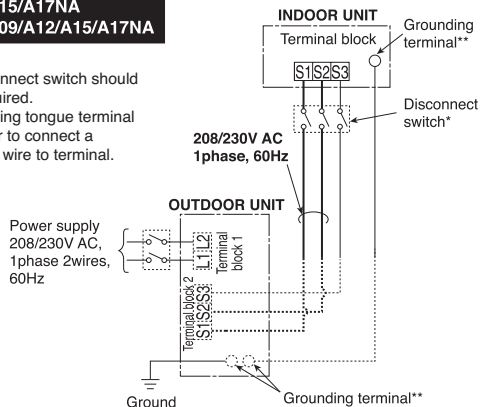

2-4. PIPE FORMING AND DRAIN PIPING

2-4-1. PIPE FORMING

- Place the drain hose below the refrigerant piping.
- Make sure that the drain hose is not heaved or snaked.
- Do not pull the hose when applying the tape.
- When the drain hose passes the room, be sure to wrap insulation material (obtainable at a store) around it.

Note:

Screws may damage the cover of refrigerant pipe during left piping.
Make sure not to damage the cover of refrigerant pipe.

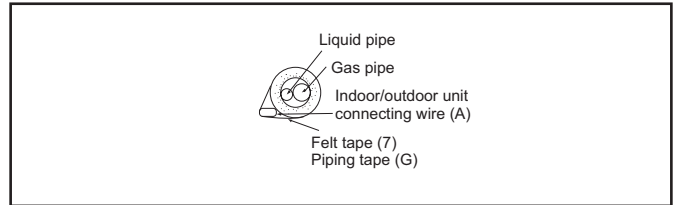

Left or left-rear piping

Note:

Be sure to reattach the drain hose and the drain cap in case of left or left-rear piping. Otherwise, it could cause drops of water to drip down from the drain hose.

- Put the refrigerant piping and the drain hose together, then firmly apply felt tape (7) from the end.
Felt tape (7) overlap width should be 1/3 the tape width. Use a bandage stopper at the end of felt tape (7).
- Pull out the drain cap at the rear right of the indoor unit. (Fig. 1)
 - Hold the convex section at the end and pull the drain cap.
- Pull out the drain hose at the rear left of the indoor unit. (Fig. 2)
 - Hold the claw marked by the arrows and pull out the drain hose forward.
- Put the drain cap into the section to which the drain hose is to be attached at the rear of the indoor unit. (Fig. 3)
 - Insert not sharp-edged tools such as screwdrivers into the hole at the end of the cap and insert the cap fully into the drain pan.
- Insert the drain hose fully into the drain pan at the rear right of the indoor unit. (Fig. 4)
 - Check if the hose is hooked securely to the projection of its inserting part at the drain pan.
- Insert the drain hose into wall hole sleeve (C), and hook the upper part of indoor unit on installation plate (1). Then, move the indoor unit completely to the left in order to make placing the piping in the back space of the unit easier.
- Cut out a piece of cardboard from the shipping box, roll it up, hook it onto the back rib, and use it as a spacer to lift the indoor unit. (Fig. 5)
- Connect the refrigerant piping with the extension pipe (B).
- Thrust the lower part of the indoor unit into the installation plate (1).

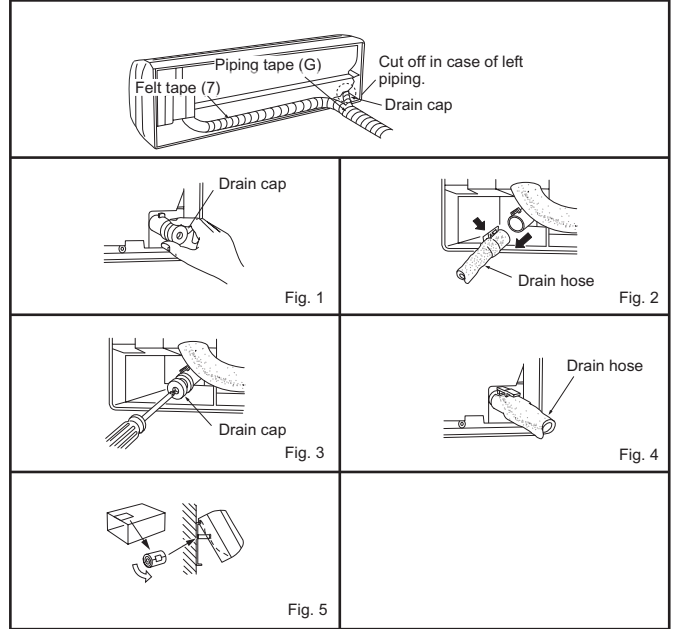

Rear or downward piping

- Put the refrigerant piping and the drain hose together, then firmly apply piping tape (G) from the end.
- Insert the piping and the drain hose into the wall hole sleeve (C), and hook the upper part of the indoor unit on the installation plate (1).
- Check if the indoor unit is hooked securely on the installation plate (1) by moving the unit to left and right.
- Thrust the lower part of the indoor unit into the installation plate (1).

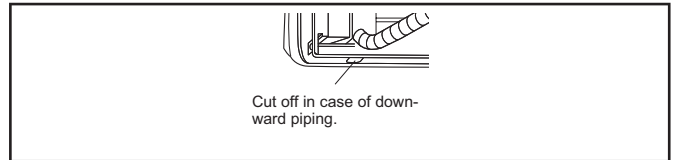

Right piping

Note:

Before performing the following, make sure that wiring is completed, and the conduit cover is installed. (Refer to 2-3.)

- Put the refrigerant piping and the drain hose together, position them to left side, and then firmly apply piping tape (G) from the end.
- Insert the piping and the drain hose into the wall hole sleeve (C), and hook the upper part of the indoor unit on the installation plate (1).
- Check if the indoor unit is hooked securely on the installation plate (1) by moving the unit to left and right.
- Thrust the lower part of the indoor unit into the installation plate (1).

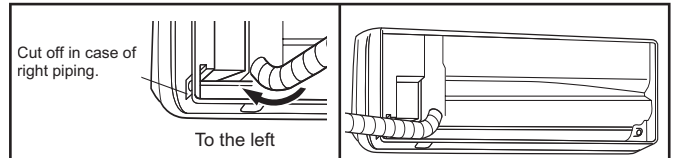

2-4-2. DRAIN PIPING

- If the extension drain hose has to pass through a room, be sure to wrap it with commercially sold insulation.
- The drain hose should point downward for easy drain flow. (Fig. 1)
- If the drain hose provided with the indoor unit is too short, connect it with drain hose (I) that should be provided at your site. (Fig. 2)
- When connecting the drain hose to the hard vinyl chloride pipe, be sure to insert it securely into the pipe. (Fig. 3)

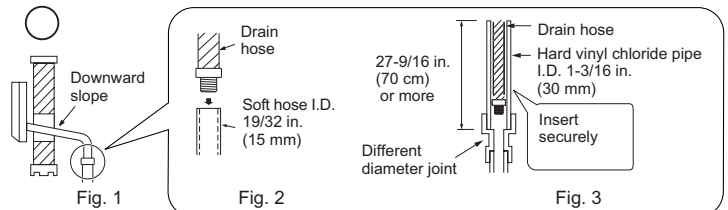

Do not make drain piping as shown below.

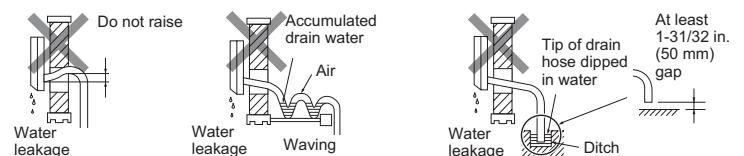

3. OUTDOOR UNIT INSTALLATION

3-1. CONNECTING WIRES FOR OUTDOOR UNIT

- 1) Remove the service panel.
- 2) Remove the conduit cover.
- 3) Fix the conduit connector to conduit plate (A models)/conduit cover (B models) with lock nut then secure it against unit with screws.
- 4) Loosen terminal screw, and connect indoor/outdoor unit connecting wire (A) from the indoor unit correctly on the terminal block. Be careful not to make mis-wiring. Fix the wire to the terminal block securely so that no part of its core is appeared, and no external force is conveyed to the connecting section of the terminal block.
- 5) Firmly tighten the terminal screws to prevent them from loosening. After tightening, pull the wires lightly to confirm that they do not move.
- 6) Connect power supply cord (K).
- 7) Connect ground wires of indoor/outdoor unit connecting wire (A) and power supply cord (K) to the TB support.
- 8) Install the conduit cover.
- 9) Install the service panel securely.

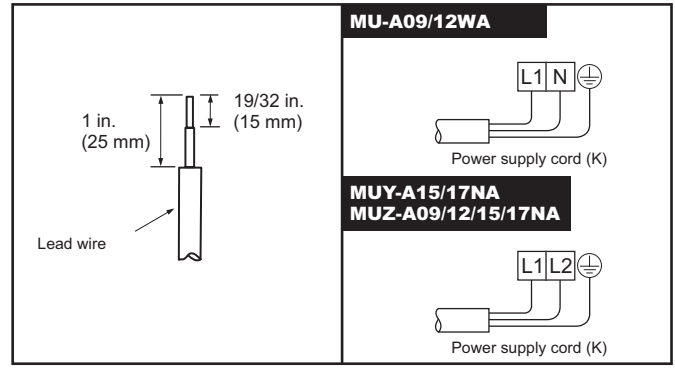

A MU-A09WA MUY-A15/17NA MUZ-A09/12/15/17NA

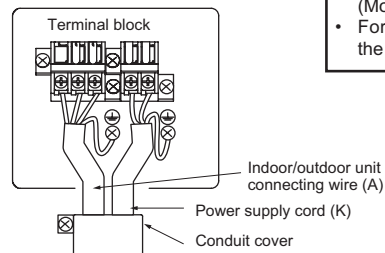
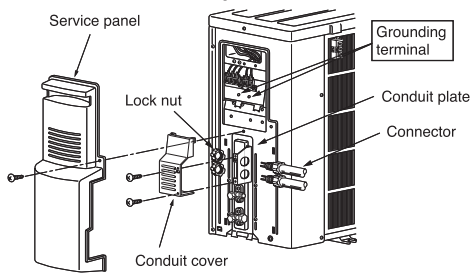

- Make earth wire a little longer than others. (More than 1-12/32 in. 35 mm)
- For future servicing, give extra length to the connecting wires.

B MU-A12WA

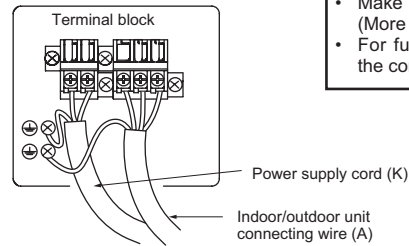
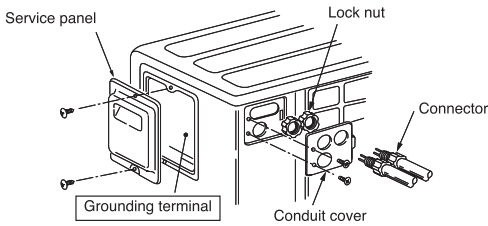

- Make earth wire a little longer than others. (More than 1-12/32 in. 35 mm)
- For future servicing, give extra length to the connecting wires.

3-2. FLARING WORK

- 1) Cut the copper pipe correctly with pipe cutter. (Fig. 1, 2)
- 2) Completely remove all burrs from the cut cross section of pipe. (Fig. 3)
 - Put the end of the copper pipe to downward direction as you remove burrs in order to avoid to let burrs drop in the piping.
- 3) Remove flare nuts attached to indoor and outdoor units, then put them on pipe having completed burr removal. (Not possible to put them on after flaring work.)
- 4) Flaring work (Fig. 4, 5). Firmly hold copper pipe in the dimension shown in the table. Select A mm from the table according to the tool you use.
- 5) Check
 - Compare the flared work with Fig. 6.
 - If flare is noted to be defective, cut off the flared section and do flaring work again.

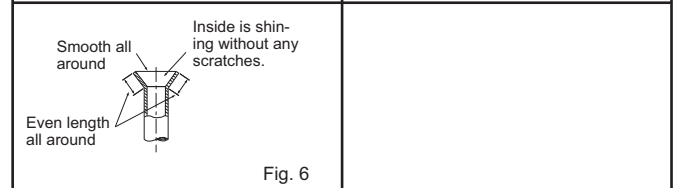
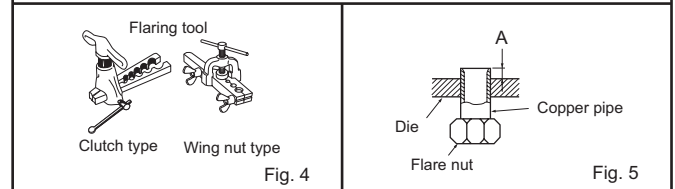
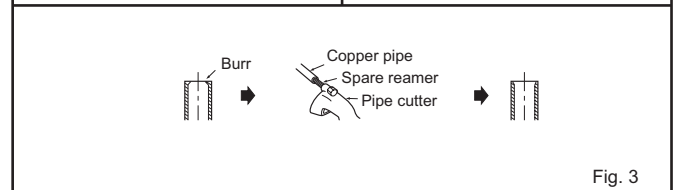
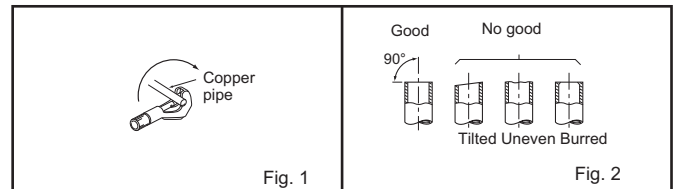

Pipe diameter inch (mm)	Nut inch (mm)	A inch (mm)			Tightening torque	
		Clutch type tool for R410A	Clutch type tool for R22	Wing nut type tool for R22	N•m	ft•lb (kgf•cm)
ø 1/4 (6.35)	1/4 (17)	0 to 0.02 (0 to 0.5)	0.04 to 0.06 (1.0 to 1.5)	0.06 to 0.08 (1.5 to 2.0)	13.7 to 17.7	10 to 13 (140 to 180)
ø 3/8 (9.52)	3/8 (22)			34.3 to 41.2	25 to 30 (350 to 420)	
ø 1/2 (12.7)	1/2 (26)			49.0 to 56.4	36 to 42 (500 to 575)	
ø 5/8 (15.88)	5/8 (29)			73.5 to 78.4	54 to 58 (750 to 800)	

3-3. PIPE CONNECTION

- Fasten flare nut with a torque wrench as specified in the table.
- When fastened too tight, flare nut may brake after a long period and cause refrigerant leakage.

Indoor unit connection

Connect both liquid and gas pipings to indoor unit.

- Apply a thin coat of refrigeration oil (J) on the seat surface of pipe.
- For connection, first align the center, then tighten the first 3 to 4 turns of flare nut.
- Use tightening torque table below as a guideline for indoor unit side union joint section, and tighten using two wrenches. Excessive tightening damages the flare section.

Outdoor unit connection

Connect pipes to stop valve pipe joint of the outdoor unit in the same manner applied for indoor unit.

- For tightening, use a torque wrench or spanner and use the same tightening torque applied for indoor unit.

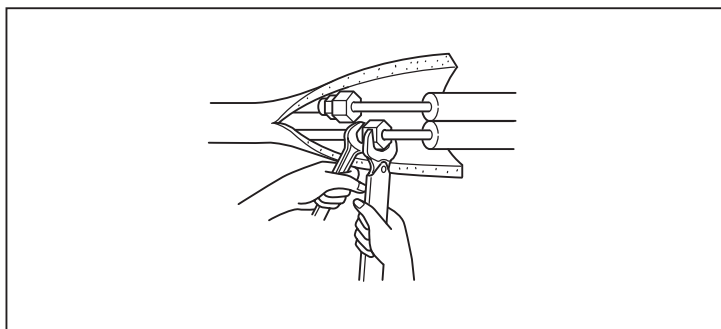

3-4. INSULATION AND TAPING

- 1) Cover piping joints with pipe cover.
- 2) For outdoor unit side, surely insulate every piping including valves.
- 3) Using piping tape (G), apply taping starting from the entry of outdoor unit.
 - Stop the end of piping tape (G) with tape (with adhesive agent attached).
 - When piping have to be arranged through above ceiling, closet or where the temperature and humidity are high, wind additional commercially sold insulation to prevent condensation.

4. PURGING PROCEDURES, LEAK TEST, AND TEST RUN

4-1. PURGING PROCEDURES AND LEAK TEST

- 1) Remove service port cap of stop valve on the side of the outdoor unit gas pipe. (The stop valve will not work in its initial state fresh out of the factory, totally closed with cap on.)
- 2) Connect gauge manifold valve and vacuum pump to service port of stop valve on the gas pipe side of the outdoor unit.

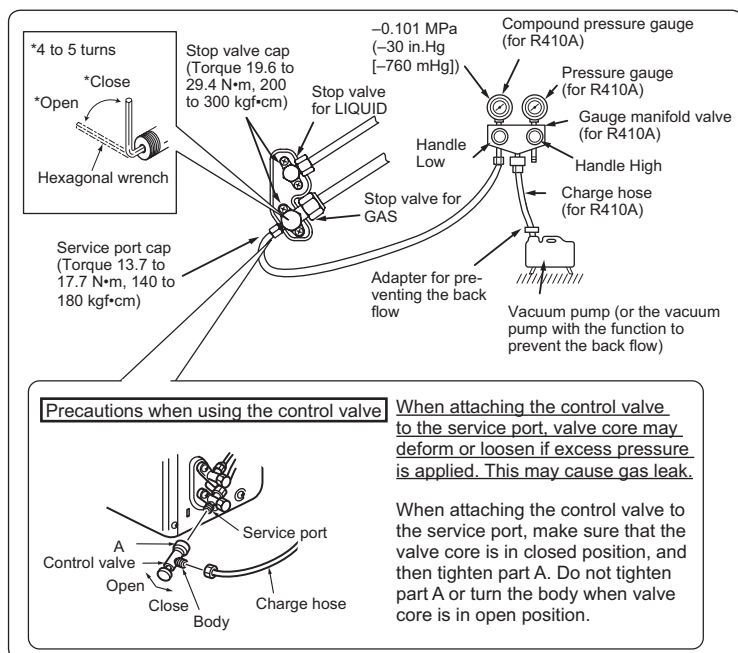

- 3) Run the vacuum pump. (Vacuumize for more than 15 minutes.)
- 4) Check the vacuum with gauge manifold valve, then close gauge manifold valve, and stop the vacuum pump.
- 5) Leave as it is for one or two minutes. Make sure pointer gauge manifold valve remains in the same position. Confirm that pressure gauge shows -0.101 Mpa [Gauge] (-30 in.Hg [-760 mmHg]).
- 6) Remove gauge manifold valve quickly from service port of stop valve.
- 7) After refrigerant pipes are connected and evacuated, fully open all stop valves on both sides of gas pipe and liquid pipe. Operating without fully opening lowers the performance and this causes trouble.
- 8) Refer to 1-3., and charge the prescribed amount of refrigerant if needed. Be sure to charge slowly with liquid refrigerant. Otherwise, composition of the refrigerant in the system may be changed and affect performance of the air conditioner.
- 9) Tighten cap of service port to obtain the initial status.
- 10) Leak test

4-2. TEST RUN

- 1) Insert power supply plug into the power outlet and/or turn on the breaker. Check that all LED lamps are not lit. If they are blinking, check that the horizontal vane is installed correctly. Refer to operating instructions for details.
- 2) Press the E.O. SW. Test run will be performed for 30 minutes. If the left side lamp of the operation indicator blinks every 0.5 seconds, inspect the indoor/outdoor unit connecting wire (A) for mis-wiring. After the test run, emergency COOL mode (75°F [24°C] COOL) will start.
- 3) To stop operation, press the E.O. SW several times until all LED lamps turn off. Refer to operating instructions for details.

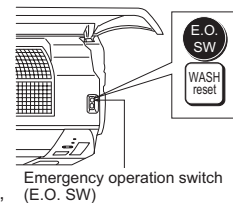

Checking the remote (infrared) signal reception

Press the ON/OFF button on the remote controller and check that an electronic sound is heard from the indoor unit. Press the ON/OFF button again to turn the air conditioner off.

- Once the compressor stops, the restart preventive device operates so the compressor will not operate for 3 minutes to protect the air conditioner.

4-3. AUTO RESTART FUNCTION

This product is equipped with an auto restart function. When the power supply is stopped during operation, such as during blackouts, the function automatically starts operation in the previous setting once the power supply is resumed. (Refer to the operating instructions for details.)

Caution:

- After test run or remote signal reception check, turn off the unit with the E.O. SW or the remote controller before turning off the power supply. Not doing so will cause the unit to start operation automatically when power supply is resumed.

To the user

- After installing the unit, make sure to explain the user about auto restart function.
- If auto restart function is unnecessary, it can be deactivated. Consult the service representative to deactivate the function. Refer to the service manual for details.

4-4. EXPLANATION TO THE USER

- Using the OPERATING INSTRUCTIONS, explain to the user how to use the air conditioner (how to use the remote controller, how to remove the air filters, how to remove or put the remote controller in the remote controller holder, how to clean, precautions for operation, etc.)
- Recommend the user to read the OPERATING INSTRUCTIONS carefully.

5. RELOCATION AND MAINTENANCE

5-1. REMOVING AND INSTALLING THE PANEL ASSEMBLY

Removal procedure

- 1) Remove the 2 screws which fix the panel assembly.
- 2) Remove the panel assembly. Be sure to remove its bottom end first.

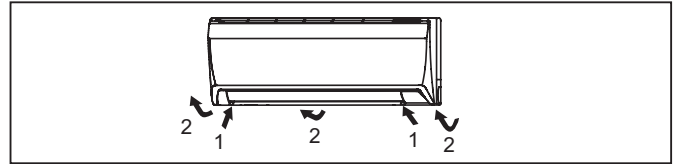

Installation procedure

- 1) Install the panel assembly following the removal procedure in reverse.
- 2) Be sure to press the positions as indicated by the arrows in order to attach the assembly completely to the unit.

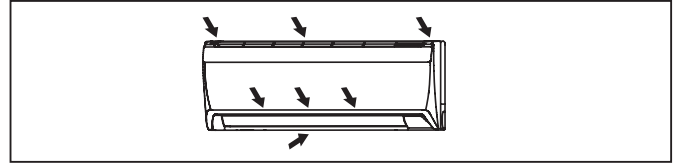

5-2. REMOVING THE INDOOR UNIT

Remove the bottom of the indoor unit from the installation plate.

When releasing the corner part, release both left and right bottom corner part of indoor unit and pull it downward and forward as shown in the figure on the right.

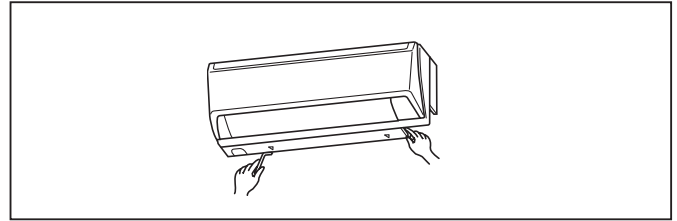

If the above method cannot be used

Remove the front panel. Then, insert hexagonal wrenches into the square holes on the left and right sides of the unit and push them up as shown in the following figure. The bottom of the indoor unit lowers and releases the hooks.

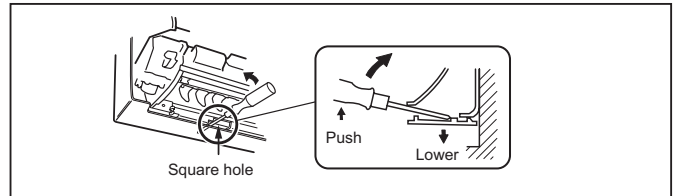

5-3. PUMPING DOWN

When relocating or disposing of the air conditioner, pump down the system following the procedure below so that no refrigerant is released into the atmosphere.

- 1) Connect the gauge manifold valve to the service port of the stop valve on the gas pipe side of the outdoor unit.
- 2) Fully close the stop valve on the liquid pipe side of the outdoor unit.
- 3) Close the stop valve on the gas pipe side of the outdoor unit almost completely so that it can be easily closed fully when the pressure gauge shows 0 MPa [Gauge] (0 lbf/in.² [0 kgf/cm²]).
- 4) Start the emergency COOL operation.
To start the emergency operation in COOL mode, disconnect the power supply plug and/or turn off the breaker. After 15 seconds, connect the power supply plug and/or turn on the breaker, and then press the E.O. SW once. (The emergency COOL operation can be performed continuously for up to 30 minutes.)
- 5) Fully close the stop valve on the gas pipe side of the outdoor unit when the pressure gauge shows 0.05 to 0 MPa [Gauge] (approx. 7.25 to 0 lbf/in.² [0.5 to 0 kgf/cm²]).
- 6) Stop the emergency COOL operation.
Press the E.O. SW twice to stop the operation.

 **MITSUBISHI ELECTRIC CORPORATION**

HEAD OFFICE: TOKYO BLDG., 2-7-3, MARUNOUCHI, CHIYODA-KU, TOKYO
100-8310, JAPAN