

**DAIKIN**

DAIKIN ROOM AIR CONDITIONER

# OPERATION MANUAL

English

Français

Español



***INVERTER***

Enjoy year-round comfort.

## MODELS

FTX30NVJU

FTX36NVJU

# Features

## Enhanced comfort and energy savings



### INTELLIGENT EYE

The INTELLIGENT EYE sensor detects human movement in a room. If no one is in the room for more than 20 minutes, the operation automatically changes to energy saving operation.

▶ Page 15



### WEEKLY TIMER

Up to 4 timer settings can be saved for each day of the week according to your family's life style. The WEEKLY TIMER allows you to set on/off times and the desired temperature. ▶ Page 21

## Other functions



### COMFORT AIRFLOW

The airflow direction is upward while in COOL and DRY operation, and downward while in HEAT operation. This function prevents cold or warm air from blowing directly on your body. ▶ Page 15



### OUTDOOR UNIT QUIET

OUTDOOR UNIT QUIET operation assures a low noise level of the outdoor unit. This function is useful to maintain a quiet neighborhood.



▶ Page 18

# Contents



## ■ Read Before Operation

Safety Considerations.....	3
Names of Parts .....	5
Preparation Before Operation .....	9



## ■ Basic Operation

 AUTO · DRY · COOL · HEAT · FAN Operation .....	11
 Adjusting the Airflow Rate.....	13
 Adjusting the Airflow Direction .....	14

## ■ Useful Functions

 COMFORT AIRFLOW / INTELLIGENT EYE Operation.....	15
 POWERFUL Operation.....	17
 ECONO / OUTDOOR UNIT QUIET Operation .....	18

## ■ TIMER Operation

 ON/OFF TIMER Operation .....	19
 WEEKLY TIMER Operation.....	21

## ■ Care

Care and Cleaning.....	27
------------------------	----

## ■ When the Need Arises

FAQ.....	32
Troubleshooting .....	33



### ECONO

This function enables efficient operation by limiting the maximum power consumption. It is useful when using the air conditioner and other electrical devices simultaneously on a shared electrical circuit. ▶Page 18

# Safety Considerations

Read these **Safety Considerations for Operations** carefully before operating an air conditioner or heat pump.

Make sure that the unit operates properly during the startup operation. Instruct the user on how to operate and maintain the unit.

Inform users that they should store this operation manual with the installation manual for future reference.

Meanings of **DANGER**, **WARNING**, **CAUTION**, and **NOTE** Symbols:

 **DANGER** ..... Indicates an imminently hazardous situation which, if not avoided, will result in death or serious injury.

 **WARNING** ..... Indicates a potentially hazardous situation which, if not avoided, could result in death or serious injury.

 **CAUTION** ..... Indicates a potentially hazardous situation which, if not avoided, may result in minor or moderate injury. It may also be used to alert against unsafe practices.

 **NOTE** ..... Indicates situations that may result in equipment or property-damage accidents only.

## **DANGER**

- Do not install the unit in an area where flammable materials are present due to risk of explosion resulting in serious injury or death.
- Any abnormalities in the operation of the air conditioner or heat pump, such as smoke or fire, could result in severe injury or death. Turn off the power and contact your dealer immediately.
- Refrigerant gas may produce toxic gas if it comes into contact with fire, such as from a fan heater, stove, or cooking device. Exposure to this gas could cause severe injury or death.
- For refrigerant leakage, consult your dealer. Refrigerant gas is heavier than air and replaces oxygen. A massive leak could lead to oxygen depletion, especially in basements, and an asphyxiation hazard could occur leading to serious injury or death.
- If equipment utilizing a burner is used in the same room as the air conditioner or heat pump, there is the danger of oxygen deficiency which could lead to an asphyxiation hazard resulting in serious injury or death. Be sure to ventilate the room sufficiently to avoid this hazard.
- Safely dispose of the packing materials. Packing materials, such as nails and other metal or wooden parts, may cause stabs or other injuries.
- Tear apart and throw away plastic packaging bags so that children will not play with them. Children playing with plastic bags face the danger of death by suffocation.

## **WARNING**

- Contact your dealer for repair and maintenance. Improper repair and maintenance may result in water leakage, electric shock, and fire. Only use accessories made by Daikin that are specifically designed for use with the equipment and have them installed by a professional.
- Contact your dealer to move and reinstall the air conditioner or heat pump. Incomplete installation may result in water leakage, electric shock, and fire.
- Never let the indoor unit or the remote controller get wet. Water can cause an electric shock or a fire.
- Never use flammable spray such as hair spray, lacquer, or paint near the unit. Flammable spray may cause a fire.
- When a fuse blows out, never replace it with one of incorrect ampere ratings or different wires. Always replace any blown fuse with a fuse of the same specification.
- Never remove the fan guard of the unit. A fan rotating at high speed without the fan guard is very dangerous.
- Never inspect or service the unit by yourself. Contact a qualified service person to perform this work.
- Turn off all electrical power before doing any maintenance to avoid the risk of serious electric shock; never sprinkle or spill water or liquids on the unit.
- Do not touch the switch with wet fingers. Touching a switch with wet fingers can cause electric shock.
- Do not allow children to play on or around the unit to prevent injury.
- The heat exchanger fins are sharp enough to cut. To avoid injury wear gloves or cover the fins while working around them.
- Do not put a finger or other objects into the air inlet or air outlet. The fan is rotating at high speed and will cause injury.
- Check the unit foundation for damage on a continuous basis, especially if it has been in use for a long time. If left in a damaged condition the unit may fall and cause injury.
- Placing a flower vase or other containers with water or other liquids on the unit could cause a shock or fire if a spill occurs.
- Do not touch the air outlet or horizontal blades while the swing flap is in operation because fingers could get caught and injured.
- Never touch the internal parts of the controller. Do not remove the front panel because some parts inside are dangerous to touch. To check and adjust internal parts, contact your dealer.

## **CAUTION**

- Do not use the air conditioner or heat pump for any other purposes other than comfort cooling or heating. Do not use the unit for cooling precision instruments, food, plants, animals or works of art.



- Do not place items under the indoor unit as they may be damaged by condensates that may form if the humidity is above 80% or if the drain outlet gets blocked.
- Before cleaning, stop the operation of the unit by turning the power off or by pulling the supply cord out from its receptacle. Otherwise, an electric shock and injury may result.
- Do not wash the air conditioner or heat pump with excessive water. An electric shock or fire may result.
- Avoid placing the controller in a spot splashed with water. Water entering the controller may cause an electric shock or damage the internal electronic parts.
- Do not operate the air conditioner or heat pump when using a room-fumigation type of insecticide. Failure to observe this could cause the chemicals to be deposited in the unit and can endanger the health of those who are hypersensitive to chemicals.
- Do not turn off the power immediately after stopping operation. Always wait for at least 5 minutes before turning off the power. Otherwise, water leakage may occur.
- The appliance is not intended for use by young children or infirm persons without supervision.
- The remote controller should be kept away from children so they cannot play with it.
- Consult with the installation contractor for cleaning.
- Incorrect cleaning of the inside of the air conditioner or heat pump could make the plastics parts break and cause water leakage or electric shock.
- Do not touch the air inlet or aluminum fin of the air conditioner or heat pump as they can cut and cause injury.
- Do not place objects in direct proximity of the outdoor unit. Do not let leaves and other debris accumulate around the unit. Leaves are a hotbed for small animals which can enter the unit. Once inside the unit, animals can cause the unit to malfunction, and cause smoke or fire when they make contact with electrical parts.
- Do not wipe the controller operation panel with benzene, thinner, chemical dust cloth, etc. The panel may get discolored or the coating can peel off. If it is heavily dirty, soak a cloth in water-diluted neutral detergent, squeeze it well and wipe the panel clean. Then wipe it with another dry cloth.
- Dismantling of the unit, disposal of the refrigerant, oil, and additional parts, should be done in accordance with the relevant local, state, and national regulations.
- Operate the air conditioner or heat pump in a sufficiently ventilated area and not surrounded by obstacles. Do not use the air conditioner or heat pump in the following places.
  - a. Places with a mist of mineral oil, such as cutting oil.
  - b. Locations such as coastal areas where there is a lot of salt in the air.
  - c. Locations such as hot springs where there is a lot of sulfur in the air.
  - d. Locations such as factories where the power voltage varies a lot.
  - e. In cars, boats, and other vehicles.
  - f. Locations such as kitchens where oil may splatter or where there is steam in the air.
  - g. Locations where equipment produces electromagnetic waves.
  - h. Places with an acid or alkaline mist.
  - i. Places where fallen leaves can accumulate or where weeds can grow.
- Take snow protection measures. Contact your dealer for the details of snow protection measures, such as the use of a snow protection hood.
- Do not attempt to do electrical work or grounding work unless you are licensed to do so. Consult with your dealer for electrical work and grounding work.
- Pay attention to operating sound. Be sure to use the following places:
  - a. Places that can sufficiently withstand the weight of the air conditioner or heat pump yet can suppress the operating sound and vibration.
  - b. Places where warm air from the air outlet of the outdoor unit or the operating sound of the outdoor unit does not annoy neighbors.

---

**NOTE**



---

- Never press the button of the remote controller with a hard, pointed object. The remote controller may be damaged.
- Never pull or twist the electric wire of the remote controller. It may cause the unit to malfunction.
- Do not place appliances that produce open flames in places that are exposed to the airflow of the unit or under the indoor unit. It may cause incomplete combustion or deformation of the unit due to the heat.
- Do not expose the controller to direct sunlight. The LCD display can become discolored and may fail to display the data.
- Make sure that there are no obstacles close to the outdoor unit. Obstacles close to the outdoor unit may drop the performance of the outdoor unit or increase the operating sound of the outdoor unit.
- Consult your dealer if the air conditioner or heat pump in operation generates unusual noise.
- Make sure that the drainpipe is installed properly to drain water. If no water is discharged from the drainpipe while the air conditioner or heat pump is in the cooling mode, the drainpipe may be clogged with dust or dirt and water leakage from the indoor unit may occur. Stop operating the air conditioner or heat pump and contact your dealer.

FTP001-U

# Names of Parts

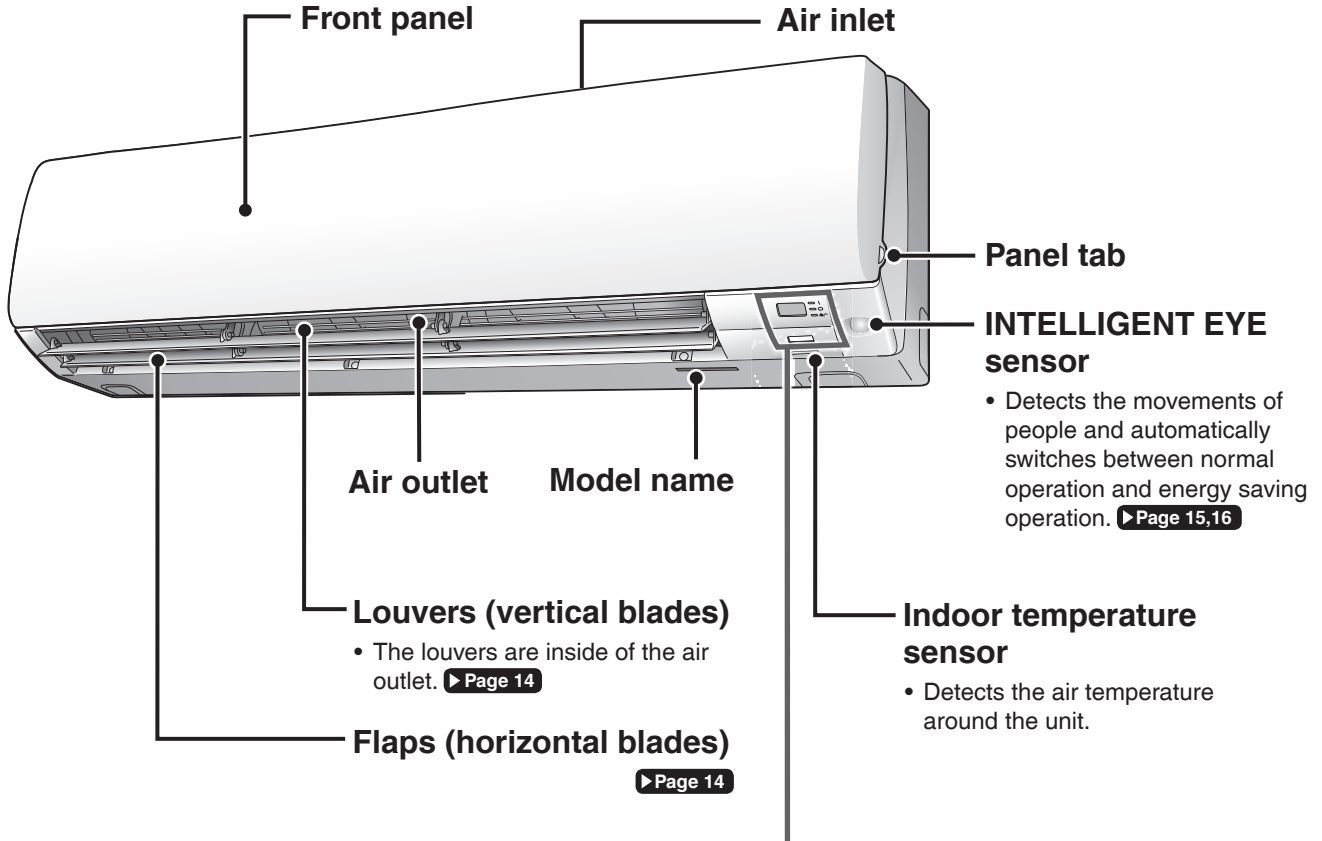
## Indoor Unit



## Display

### Signal receiver

- Receives signals from the remote controller.
- When the unit receives a signal, you will hear a beep sound.

Case	Sound type
Operation start	beep-beep
Setting changed	beep
Operation stop	long beep

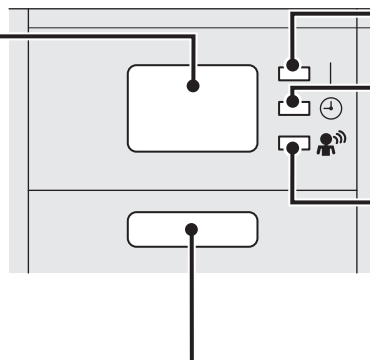

**OPERATION lamp (green)**

**TIMER lamp (orange)**

▶ Page 19,20,23

**INTELLIGENT EYE lamp (green)**

▶ Page 15

### Indoor unit ON/OFF switch

- Press this switch once to start operation. Press once again to stop it.
- For the operation mode setting, refer to the following table.

Model	Mode	Temperature setting	Airflow rate
HEAT PUMP	AUTO	77°F (25°C)	AUTO
COOLING ONLY	COOL	72°F (22°C)	AUTO

- This switch can be used when the remote controller is missing.

■ Open the front panel

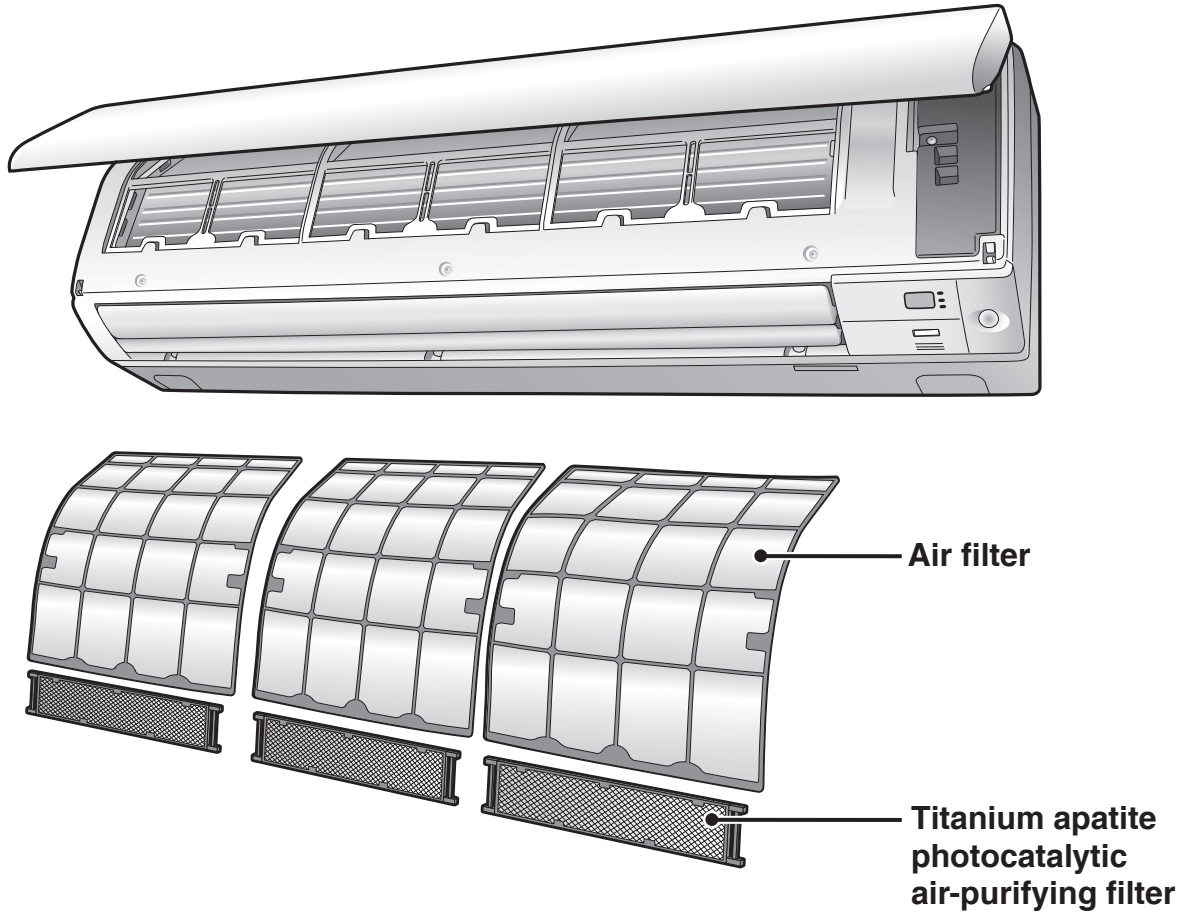

**Outdoor Unit**

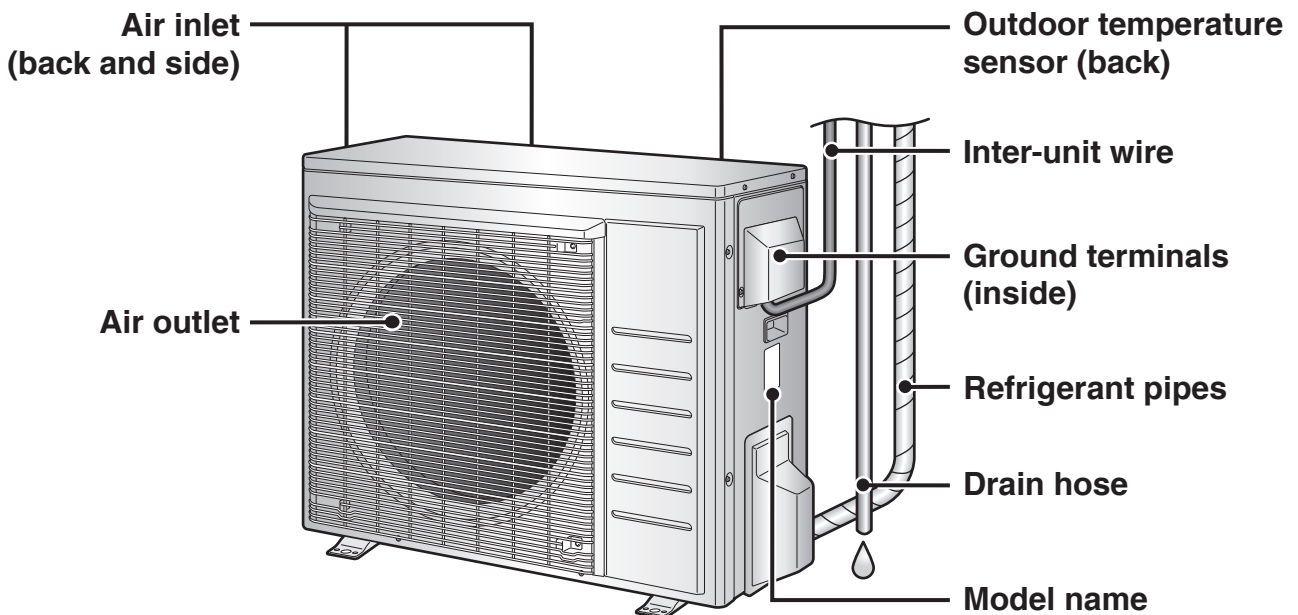

# Names of Parts

## Remote Controller

### Signal transmitter

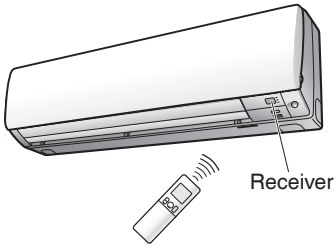

- To use the remote controller, aim the transmitter at the indoor unit. If there is anything blocking the signals between the unit and the remote controller, such as a curtain, the unit may not operate.
- The maximum transmission distance is about 23ft (7m).

### Display (LCD)

- Displays the current settings. (In this illustration, each section is shown with all its displays on for the purpose of explanation.)

### TEMPERATURE adjustment button

- Changes the temperature setting.

▶ Page 12

### ON/OFF button

- Press this button once to start operation. Press once again to stop it.

▶ Page 11

### Front cover

- Open the front cover.

▶ Page 8

### FAN setting button

- Selects the airflow rate setting.

▶ Page 13

### POWERFUL button

- POWERFUL operation.

▶ Page 17

Model

ARC466A37



■ Open the front cover

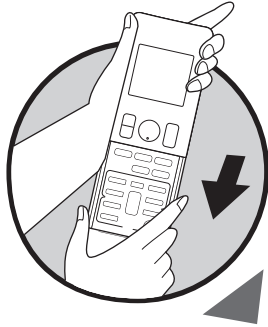

**MODE selector button**  
 • Selects the operation mode.  
 (AUTO/DRY/COOL/HEAT/  
 FAN) ▶Page 11

**ECONO/QUIET button**  
 • ECONO/OUTDOOR UNIT  
 QUIET operation. ▶Page 18

**SWING button**  
 • Adjusts the airflow direction.  
 ▶Page 14

Weekly  
 : WEEKLY button  
 : PROGRAM button  
 Copy  
 : COPY button  
 Back  
 : BACK button  
 Next  
 : NEXT button  
 • WEEKLY TIMER operation.  
 ▶Page 21

**ON TIMER button**  
 ▶Page 19

**CLOCK button** ▶Page 10

**COMFORT/SENSOR button**  
 • COMFORT AIRFLOW /  
 INTELLIGENT EYE  
 operation. ▶Page 15

**OFF TIMER button  
 (NIGHT SET mode)**  
 ▶Page 20

**TIMER CANCEL button**  
 • Cancels the timer setting.  
 ▶Page 19,20  
 • Cannot be used for the  
 WEEKLY TIMER operation.

**SELECT button**  
 • Changes the clock, ON/OFF  
 TIMER and WEEKLY TIMER  
 settings.

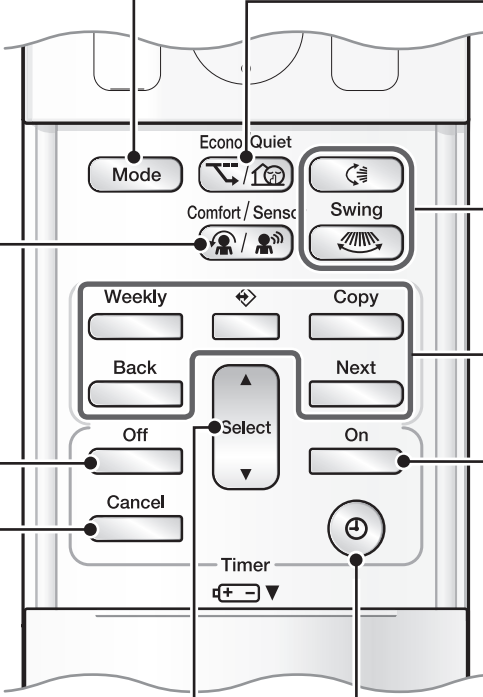

# Preparation Before Operation

## CAUTION

Incorrect handling of batteries can result in injury from battery leakage, rupturing or heating, or lead to equipment failure.

Please observe the following precautions and use safely.

- If the alkaline solution from the batteries should get in the eyes, do not rub the eyes. Instead, immediately flush the eyes with tap water and seek the attention of a medical professional.
- Keep batteries out of reach of children. In the event that batteries are swallowed, seek the immediate attention of a medical professional.
- Do not expose batteries to heat or fire. Do not disassemble or modify batteries. The insulation or gas release vent inside the battery may be damaged, resulting in battery leakage, rupturing, or heating.
- Do not damage or peel off labels on the batteries.

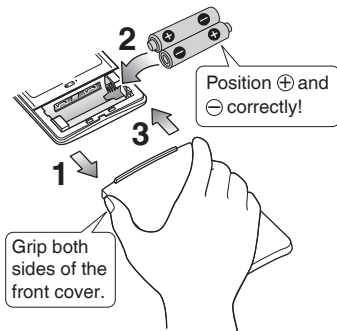

### To insert the batteries

1. Slide the front cover to take it off.
2. Insert 2 dry batteries AAA.LR03 (alkaline).
3. Replace the front cover.

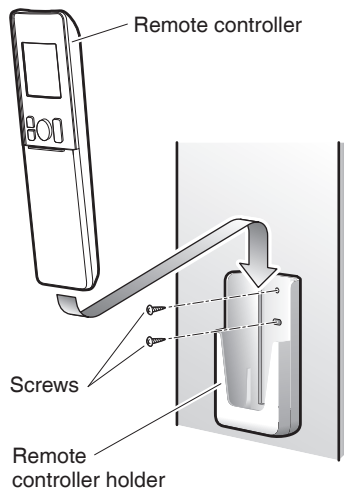



### To attach the remote controller holder to a wall

1. Choose a place where the signals reach the unit.
2. Attach the holder to a wall, a pillar, or similar location with the screws supplied with the holder.
3. Place the remote controller in the remote controller holder.

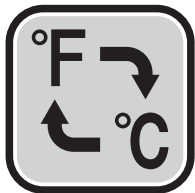
### Fahrenheit/Celsius display switch



- Press  and  (TIMER button) simultaneously for about 5 seconds.

- The temperature will be displayed in Celsius when it is presently displayed in Fahrenheit, and vice versa.
- The switch operation is only possible when the temperature is being displayed.

## NOTE

### Notes on batteries

- To avoid possible injury or damage from battery leakage or rupturing, remove the batteries when not using the product for long periods of time.
- The standard replacement time is about 1 year. Both batteries should be replaced at the same time. Be sure to replace them with new size AAA.LR03 (alkaline) batteries. However, if the remote controller display begins to fade and the possible transmission range becomes shorter within a year, replace both batteries as specified above.
- The batteries supplied with the remote controller are for initial operation. The batteries may run out in less than 1 year.

### Note on remote controller

- Do not drop the remote controller. Do not get it wet.

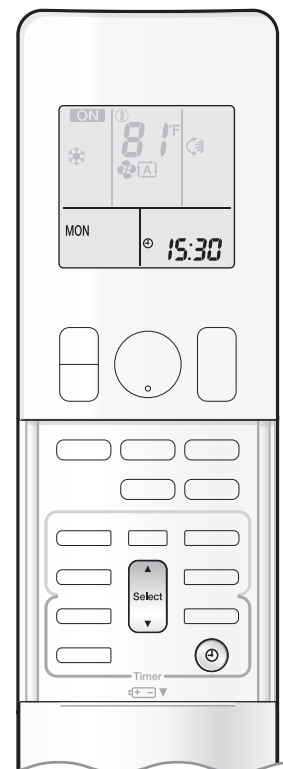

## Turn on the circuit breaker

- After the power is turned on, the flaps of the indoor unit open and close once to set the reference position.

## To set the clock

### 1. Press .



“0:00” is displayed on the LCD.  
“MON” and “” blink.

### 2. Press to set the current day of the week.

### 3. Press .



“” blinks.

### 4. Press to set the clock to the present time.

- Holding down ▲ or ▼ rapidly increases or decreases the displayed time.

### 5. Press .

- Point the remote controller at the indoor unit when pressing the buttons.



“:” blinks.

## NOTE

### Fahrenheit/Celsius display change function of remote controller

- The set temperature may increase when the display is changed to Celsius from Fahrenheit, because a fraction of 0.5°C is rounded up.
- Example: A set temperature of 65°F (equivalent to 18.5°C) will be converted into 19°C.  
When the display is changed to Fahrenheit again, the set temperature will be converted into 66°F (equivalent to 19°C) instead of the original set temperature (65°F) but a set temperature of 66°F (equivalent to 19°C) will be converted into 19°C with no temperature change.
- A reception sound will go off for the transmission of set temperature to the indoor unit at the time of setting the Fahrenheit/Celsius display change function.

### Note on setting the clock

- If the indoor unit's internal clock is not set to the correct time, the ON/OFF TIMER and WEEKLY TIMER will not operate punctually.



# AUTO · DRY · COOL · HEAT · FAN Operation



The air conditioner operates with the operation mode of your choice. From the next time on, the air conditioner will operate with the same operation mode.

## To start operation

### 1. Press and select an operation mode.

- Each pressing of the button changes the mode setting in sequence.

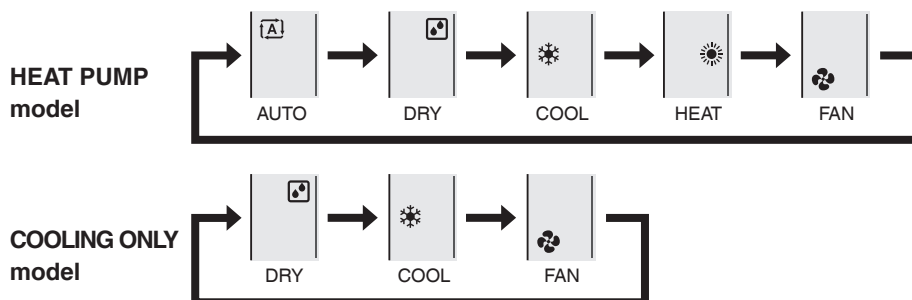

### 2. Press .

- “**ON**” is displayed on the LCD.
- The OPERATION lamp lights green.



Display

## To stop operation

### Press again.

- “**ON**” disappears from the LCD.
- The OPERATION lamp goes off.

## NOTE

### Notes on AUTO operation

- In AUTO operation, the system selects an appropriate operation mode (COOL or HEAT) based on the indoor temperature and starts the operation.
- The system automatically reselects setting at a regular interval to bring the indoor temperature to the user-setting level.

### Note on DRY operation

- Eliminates humidity while maintaining the indoor temperature as much as possible. It automatically controls temperature and airflow rate, so manual adjustment of these functions is unavailable.

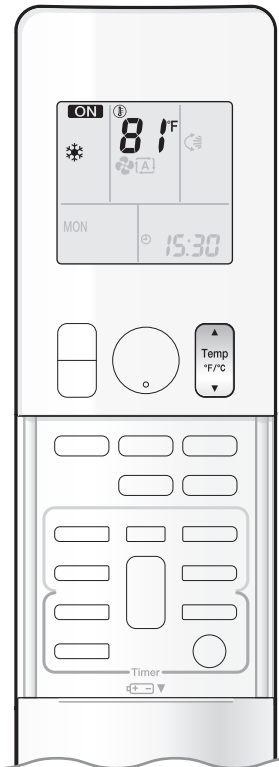

## To change the temperature setting

Press  .

- Press ▲ to raise the temperature and press ▼ to lower the temperature.

COOL operation	HEAT operation	AUTO operation	DRY or FAN operation
64-90°F (18-32°C)	50-86°F (10-30°C)	64-86°F (18-30°C)	The temperature setting cannot be changed.

## Tips for saving energy

**Keeping the temperature setting at a moderate level helps save energy.**

- Recommended temperature setting
  - For cooling: 78-82°F (26-28°C)
  - For heating: 68-75°F (20-24°C)

**Cover windows with a blind or a curtain.**

- Blocking sunlight and air from outdoors increases the cooling (heating) effect.

**Keep the air filter clean.**

- Clogged air filters cause inefficient operation and waste energy. Clean them once in about every 2 weeks. [▶ Page 29](#)

**If you are not going to use the air conditioner for a long period, for example in spring or autumn, turn off the circuit breaker.**

- The air conditioner always consumes a small amount of electricity even while it is not operating.







# Adjusting the Airflow Rate

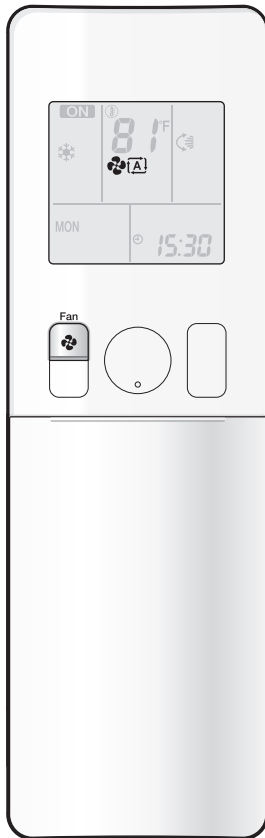



You can adjust the airflow rate to increase your comfort.

## To adjust the airflow rate setting

Press .

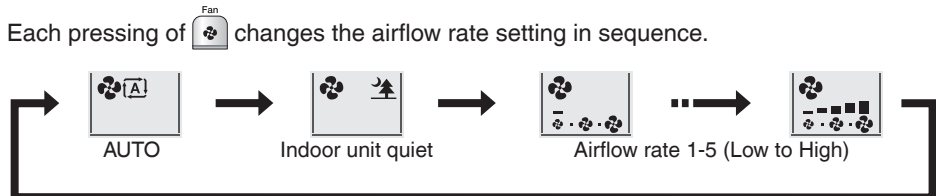
- Each pressing of  changes the airflow rate setting in sequence.



- When the airflow is set to “”, quiet operation starts and noise from the indoor unit will become quieter.
- In the quiet operation mode, the airflow rate is set to a weak level.
- In DRY operation, the airflow rate setting cannot be changed.

## NOTE

### Note on airflow rate setting

- At smaller airflow rates, the cooling (heating) effect is also smaller.



# Adjusting the Airflow Direction

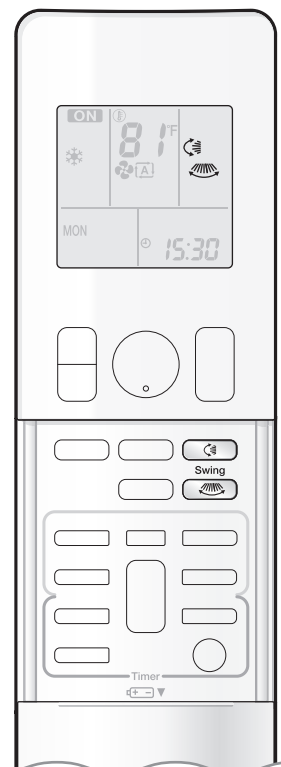

You can adjust the airflow direction to increase your comfort.

## ⚠ CAUTION

- Always use a remote controller to adjust the angles of the flaps and louvers.
  - If you attempt to move the flaps and louvers forcibly by hand when they are swinging, the mechanism may be damaged.
  - Inside the air outlet, a fan is rotating at a high speed.

### To start auto swing

#### Up and down airflow direction

Press .

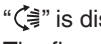
- “” is displayed on the LCD.
- The flaps (horizontal blades) will begin to swing.

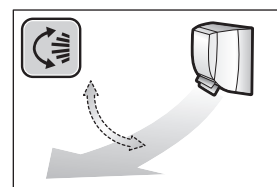

#### Right and left airflow direction



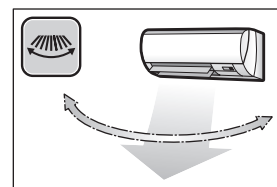

Press .

- “” is displayed on the LCD.
- The louvers (vertical blades) will begin to swing.

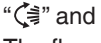

#### The 3-D airflow direction

Press  and .

- “” and “” are displayed on the LCD.
- The flaps and louvers move in turn.
- To cancel 3-D airflow, press either  or  again. The flaps or louvers will stop moving.

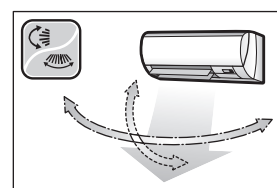

### To set the flaps or louvers at the desired position

- This function is effective while the flaps or louvers are in auto swing mode.

Press  and  when the flaps or louvers reach the desired position.

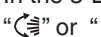
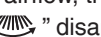
- In the 3-D airflow, the flaps and louvers move in turn.
- “” or “” disappears from the LCD.

## NOTE

### Notes on airflow direction setting

- The movable range of the flaps varies according to the operation mode.
- The flaps will stop at the upper position when the airflow rate is changed to low during the up and down swing setting.

### Note on 3-D airflow

- Using 3-D airflow circulates cold air, which tends to be collected at the bottom of the room, and hot air, which tends to collect near the ceiling, throughout the room, preventing areas of cold and hot developing.

### Movable range of the flaps

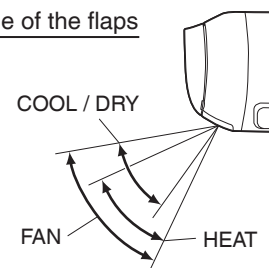



# COMFORT AIRFLOW / INTELLIGENT EYE Operation

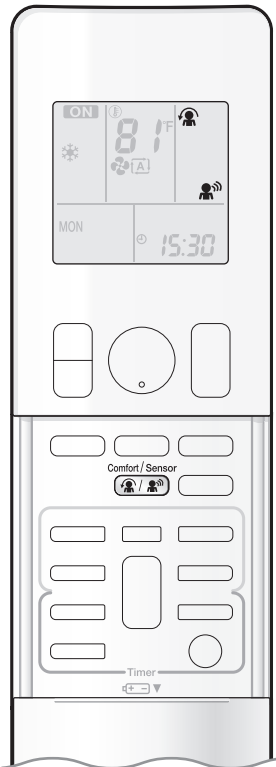

**COMFORT AIRFLOW operation:** The airflow direction is upward while in COOL and DRY operation, and downward while in HEAT operation. This function prevents cold or warm air from blowing directly on the occupants in the room.

**INTELLIGENT EYE operation:** The INTELLIGENT EYE sensor detects human movement. If no one is in the room for more than 20 minutes, the operation automatically changes to energy saving operation.

## ⚠ CAUTION

- Do not place large objects near the INTELLIGENT EYE sensor. Also keep heating units and humidifiers outside the sensor's detection area. This sensor can detect undesirable objects.
- Do not hit or violently push the INTELLIGENT EYE sensor. This can lead to damage and malfunction.

## To start operation

▶ Press  and select the desired mode.

- Each time  is pressed, a different setting option is displayed on the LCD.
- When INTELLIGENT EYE is selected, the INTELLIGENT EYE lamp lights green.

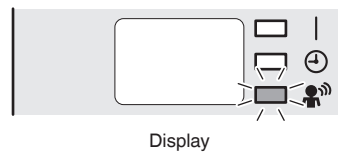

- By selecting “” from the following icons, the air conditioner will switch to COMFORT AIRFLOW operation combined with INTELLIGENT EYE operation.

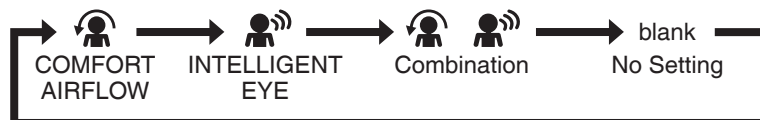

- When the flaps (horizontal blades) are swinging, selecting any of the modes above will cause the flaps (horizontal blades) to stop.

## To cancel operation

▶ Press  until no icon is displayed.

- If the INTELLIGENT EYE operation was being used, the INTELLIGENT EYE lamp goes off.

## INTELLIGENT EYE operation is useful for energy saving

### ■ People are detected in the sensing area.

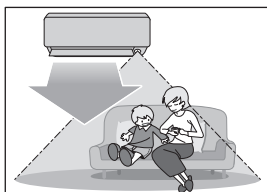

The air conditioner is in normal operation while the sensor is detecting human movement.

### ■ No people are detected in the sensing area.

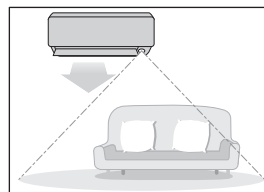

The air conditioner will switch to energy-saving mode after 20 minutes.

### Energy saving operation

- If no presence is detected in the room for 20 minutes, the energy saving operation will start, and the INTELLIGENT EYE lamp goes off. If human movement is detected again, the INTELLIGENT EYE lamp lights up and energy saving operation terminates.
- This operation changes the temperature by  $-3.6^{\circ}\text{F}$  ( $-2^{\circ}\text{C}$ ) in HEAT /  $+3.6^{\circ}\text{F}$  ( $+2^{\circ}\text{C}$ ) in COOL /  $+3.6^{\circ}\text{F}$  ( $+2^{\circ}\text{C}$ ) in DRY operation from the set temperature.  
When the room temperature exceeds  $86^{\circ}\text{F}$  ( $30^{\circ}\text{C}$ ), the operation changes the temperature by  $+1.8^{\circ}\text{F}$  ( $+1^{\circ}\text{C}$ ) in COOL /  $+1.8^{\circ}\text{F}$  ( $+1^{\circ}\text{C}$ ) in DRY operation from the set temperature.
- This operation decreases the airflow rate slightly in FAN operation only.

## NOTE

### Note on COMFORT AIRFLOW operation

- The airflow rate will be set to AUTO. If the up and down airflow direction is selected, COMFORT AIRFLOW operation will be canceled.

### Notes on INTELLIGENT EYE operation

- Application range is as follows.

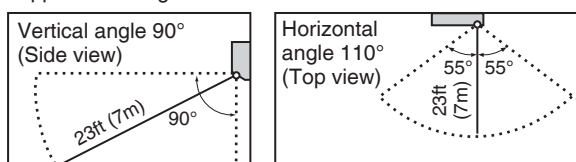

- The sensor may not detect moving objects further than 23ft (7m) away. (Please see the application range)
- Sensor detection sensitivity changes according to the indoor unit location, the speed of passers-by, temperature range, etc.
- The sensor could also mistakenly detect pets, sunlight, fluttering curtains and light reflected off of mirrors as passers-by.
- INTELLIGENT EYE operation will not switch on during POWERFUL operation.
- NIGHT SET mode **▶ Page 20** will not switch on during use of INTELLIGENT EYE operation.

### Note on combination of COMFORT AIRFLOW operation and INTELLIGENT EYE operation

- The airflow rate will be set to AUTO. If the up and down airflow direction is selected, COMFORT AIRFLOW operation will be canceled. Priority is given to the function of whichever button is pressed last.



# POWERFUL Operation

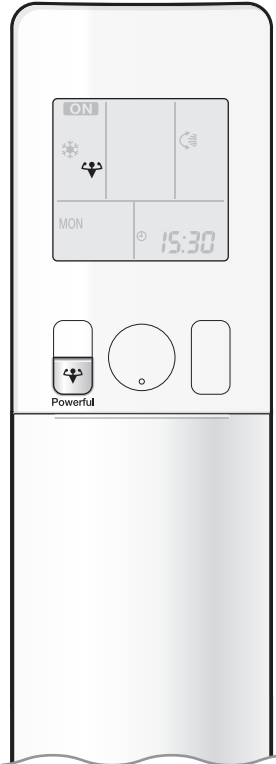

POWERFUL operation quickly maximizes the cooling (heating) effect in any operation mode. In this mode, the air conditioner operates at maximum capacity.

## To start POWERFUL operation

Press  during operation.

- “” is displayed on the LCD.
- POWERFUL operation ends in 20 minutes. Then the system automatically operates again with the previous settings which were used before POWERFUL operation.



## To cancel POWERFUL operation

Press  again.

- “” disappears from the LCD.

## NOTE

### Notes on POWERFUL operation

- Pressing  causes the settings to be canceled, and “” disappears from the LCD.
- POWERFUL operation will not increase the capacity of the air conditioner if the air conditioner is already in operation with its maximum capacity demonstrated.
  - In **COOL, HEAT and AUTO operation**  
To maximize the cooling (heating) effect, the capacity of outdoor unit increases and the airflow rate becomes fixed at the maximum setting. The temperature and airflow settings cannot be changed.
  - In **DRY operation**  
The temperature setting is lowered by 4.5°F (2.5°C) and the airflow rate is slightly increased.
  - In **FAN operation**  
The airflow rate is fixed at the maximum setting.

### Regarding the combination of POWERFUL and other operations

POWERFUL + COMFORT AIRFLOW	Not available*
POWERFUL + ECONO	
POWERFUL + OUTDOOR UNIT QUIET	

\*Priority is given to the function of whichever button is pressed last.





# ECONO / OUTDOOR UNIT QUIET Operation

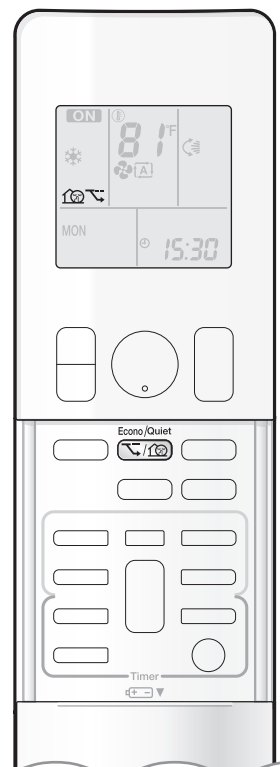

**ECONO operation** enables efficient operation by limiting the maximum power consumption.

This function is useful to prevent the circuit breaker from tripping when the unit operates alongside other appliances on the same circuit.

**OUTDOOR UNIT QUIET operation** lowers the noise level of the outdoor unit by changing the frequency and fan speed of the outdoor unit. This function is convenient during the night-time operation.

## To start operation

Press  and select the desired mode.

- Each time  is pressed, a different setting option is displayed on the LCD.

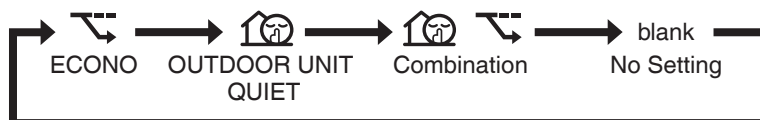



## To cancel operation

Press  until no icon is displayed.

## NOTE

### Notes on ECONO operation

- Pressing  causes the settings to be canceled, and “” disappears from the LCD.
- If the power consumption level is already low, switching to ECONO operation will not reduce the power consumption.

### Notes on OUTDOOR UNIT QUIET operation

- Even if the operation is stopped by using the remote controller or the indoor unit ON/OFF switch when using OUTDOOR UNIT QUIET operation, “” will remain displayed on the remote controller.
- OUTDOOR UNIT QUIET operation will not reduce the frequency nor fan speed if they already are operating at reduced levels.
- This operation is performed with lower power and therefore may not provide a sufficient cooling (heating) effect.

### Possible combinations of ECONO / OUTDOOR UNIT QUIET operation and basic operations

	Operation mode				
	AUTO	DRY	COOL	HEAT	FAN
ECONO	✓	✓	✓	✓	–
OUTDOOR UNIT QUIET	✓	–	✓	✓	–



# ON/OFF TIMER Operation

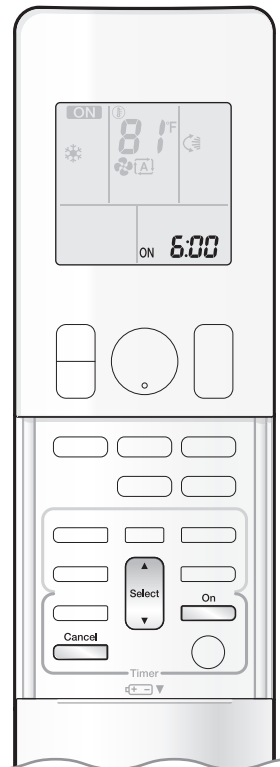

Timer functions are useful for automatically switching the air conditioner on or off in the morning or at night. You can also use the ON TIMER and OFF TIMER together.

## To use ON TIMER operation

- Check that the clock is correct.  
If not, set the clock to the present time. ▶ [Page 10](#)

**1. Press**  .

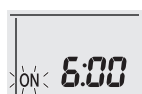

“6:00” is displayed on the LCD.  
“ON” blinks.

- “⌚” and day of the week disappear from the LCD.

**2. Press**  **until the time setting reaches the point you like.**

- Each pressing of either button increases or decreases the time setting by 10 minutes. Holding down either button changes the setting rapidly.

**3. Press**  **again.**

- “ON” and setting time are displayed on the LCD.
- The TIMER lamp lights orange. ▶ [Page 5](#)



Display

## To cancel ON TIMER operation

**Press**  .

- “ON” and setting time disappear from the LCD.
- “⌚” and day of the week are displayed on the LCD.
- The TIMER lamp goes off.

## NOTE

### Notes on TIMER operation

- When TIMER is set, the present time is not displayed.
- When using the ON/OFF TIMER to start/stop operation, the actual operation start/stop time may differ from the time set. (Maximum of about 10 minutes)
- The ON/OFF TIMER remembers the time set previously.
- The ON TIMER will begin operation in the settings used previously for operation mode, temperature, airflow rate, and airflow direction.

### In the following cases, set the timer again.

- After the circuit breaker has turned off.
- After a power failure.
- After replacing the batteries in the remote controller.

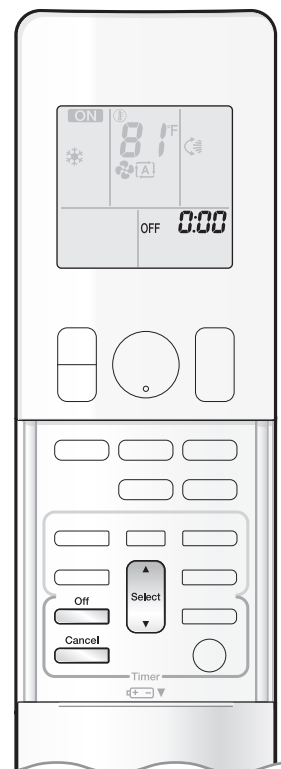

### To use OFF TIMER operation

- Check that the clock is correct.  
If not, set the clock to the present time. ▶ Page 10

#### 1. Press .

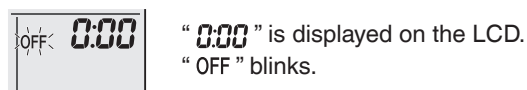

- “⌚” and day of the week disappear from the LCD.

#### 2. Press until the time setting reaches the point you like.

- Each pressing of either button increases or decreases the time setting by 10 minutes.  
Holding down either button changes the time setting rapidly.

#### 3. Press again.

- “OFF” and setting time are displayed on the LCD.
- The TIMER lamp lights orange. ▶ Page 5

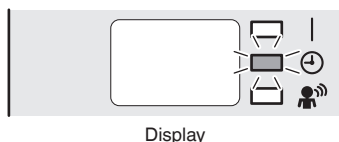

### To cancel OFF TIMER operation

#### Press .

- “OFF” and setting time disappear from the LCD.
- “⌚” and day of the week are displayed on the LCD.
- The TIMER lamp goes off.

### To combine ON TIMER and OFF TIMER operation

- A sample setting for combining the 2 timers is shown below.

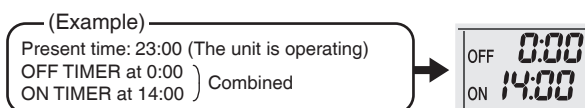

## NOTE

### NIGHT SET mode

- When the OFF TIMER is set, the air conditioner automatically adjusts the temperature setting (0.9°F (0.5°C) up in COOL, 3.6°F (2.0°C) down in HEAT) to prevent excessive cooling (heating) during sleeping hours.



# WEEKLY TIMER Operation

Up to 4 timer settings can be saved for each day of the week. This is convenient to adapt the WEEKLY TIMER to your family's life style.

## Setting example of the WEEKLY TIMER

The same timer settings are used from Monday through Friday, while different timer settings are used for the weekend.

<p><b>[Monday]</b></p>	<p>Make timer settings for programs 1-4. <a href="#">▶ Page 22</a></p> <p><b>program 1</b>      <b>program 2</b>      <b>program 3</b>      <b>program 4</b></p> <p>ON                      OFF                      ON                      OFF</p> <p>6:00                      8:30                      17:30                      22:00</p>
<p><b>[Tuesday to Friday]</b></p>	<p>Use the copy mode to make settings for Tuesday to Friday, because these settings are the same as those for Monday. <a href="#">▶ Page 24</a></p> <p><b>program 1</b>      <b>program 2</b>      <b>program 3</b>      <b>program 4</b></p> <p>ON                      OFF                      ON                      OFF</p> <p>6:00                      8:30                      17:30                      22:00</p>
<p><b>[Saturday]</b></p>	<p>No timer settings</p>
<p><b>[Sunday]</b></p>	<p>Make timer settings for programs 1-4. <a href="#">▶ Page 22</a></p> <p><b>program 1</b>      <b>program 2</b>      <b>program 3</b>      <b>program 4</b></p> <p>ON                      OFF                      OFF                      ON</p> <p>8:00                      10:00                      19:00                      21:00</p>

- Up to 4 reservations per day and 28 reservations per week can be set using the WEEKLY TIMER. The effective use of the copy mode simplifies timer programming.
- The use of ON-ON-ON-ON settings, for example, makes it possible to schedule operating mode and set temperature changes. Furthermore, by using OFF-OFF-OFF-OFF settings, only the turn off time of each day can be set. This will turn off the air conditioner automatically if you forget to turn it off.

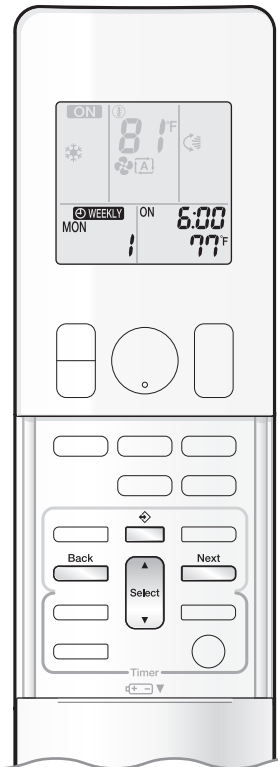

## To use WEEKLY TIMER operation

### Setting mode

- Make sure the day of the week and time are set.  
If not, set the day of the week and time. ▶ [Page 10](#)

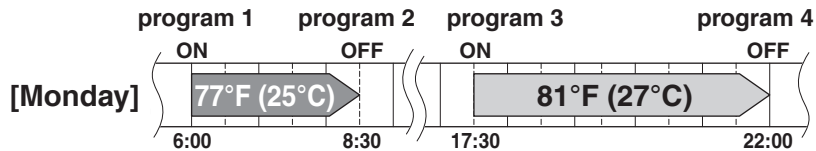

### Setting Displays

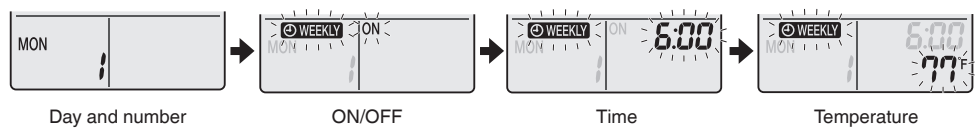

### 1. Press .

- The day of the week and the reservation number of the current day will be displayed.
- 1 to 4 settings can be made per day.

### 2. Press to select the desired day of the week and reservation number.

- Pressing changes the reservation number and the day of the week.

### 3. Press .

- The day of the week and reservation number will be set.
- “ ” and “ ON ” blink.

### 4. Press to select the desired mode.

- Pressing changes the “ ON ” or “ OFF ” setting in sequence.



- In case the reservation has already been set, selecting “ blank ” deletes the reservation.
- Proceed to **STEP 9** if “ blank ” is selected.
- To return to the day of the week and reservation number setting, press .

### 5. Press .

- The ON/OFF TIMER mode will be set.
- “ ” and the time blink.





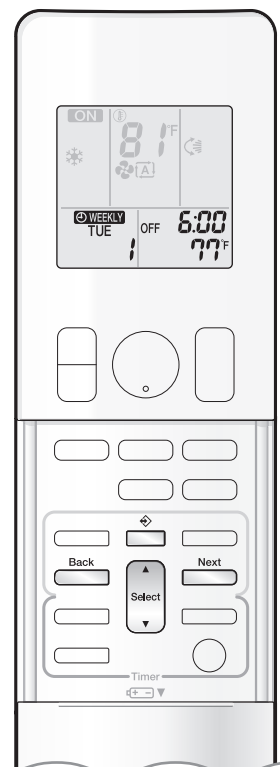

# WEEKLY TIMER Operation





## 6. Press to select the desired time.

- The time can be set between 0:00 and 23:50 in 10-minute intervals.
- To return to the ON/OFF TIMER mode setting, press .
- Proceed to **STEP 9** when setting the OFF TIMER.

## 7. Press .

- The time will be set.
- “ WEEKLY” and the temperature blink.

## 8. Press to select the desired temperature.

- The temperature can be set between 50°F (10°C) and 90°F (32°C).  
COOL or AUTO: The unit operates at 64°F (18°C) even if it is set at 50°F (10°C) to 63°F (17°C). 
- HEAT or AUTO : The unit operates at 86°F (30°C) even if it is set at 87°F (31°C) to 90°F (32°C). 
- To return to the time setting, press .
- The set temperature is only displayed when the mode setting is on.

## 9. Press .

- Check for a receiving tone and that the OPERATION lamp blinks twice.
- The TIMER lamp lights orange.
- Temperature and time are set in the case of ON TIMER operation, and the time is set in the case of OFF TIMER operation.
- The next reservation screen will appear.
- To continue further settings, repeat the procedure from **STEP 4**.







Display

## 10. Press to complete the setting.

- “ WEEKLY” is displayed on the LCD and WEEKLY TIMER operation is activated.
- A reservation made once can be easily copied and the same settings used for another day of the week. Refer to **Copy mode**. 

### NOTE

#### Notes on WEEKLY TIMER operation

- Do not forget to set the clock on the remote controller first. 
- The day of the week, ON/OFF TIMER mode, time and set temperature (only for ON TIMER mode) can be set with the WEEKLY TIMER.  
When set to ON TIMER mode, operation will begin in the settings used previously for operation mode, temperature, airflow rate, and airflow direction.
- WEEKLY TIMER and ON/OFF TIMER operation cannot be used at the same time. The ON/OFF TIMER operation has priority if it is set while WEEKLY TIMER is still active. The WEEKLY TIMER will enter the standby state, and “ WEEKLY” will disappear from the LCD. When the ON/OFF TIMER is up, the WEEKLY TIMER will automatically become active.
- Turning off the circuit breaker, power failure, and other similar events will render operation of the indoor unit's internal clock inaccurate. Reset the clock. 
-  can be used only for the time and temperature settings. It cannot be used to go back to the reservation number.

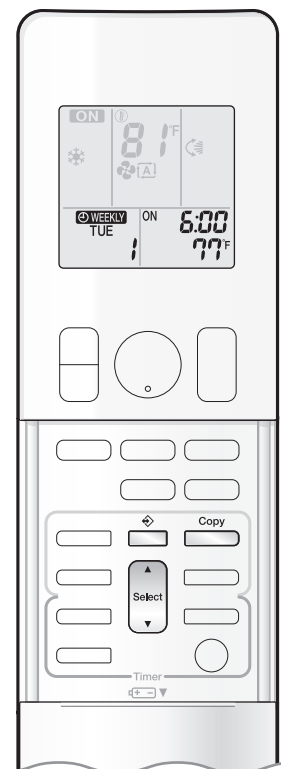

### Copy mode

- A reservation made once can be copied to another day of the week. The whole reservation of the selected day of the week will be copied.

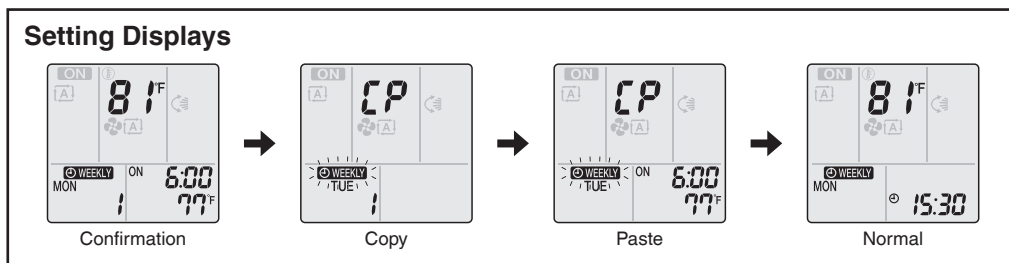
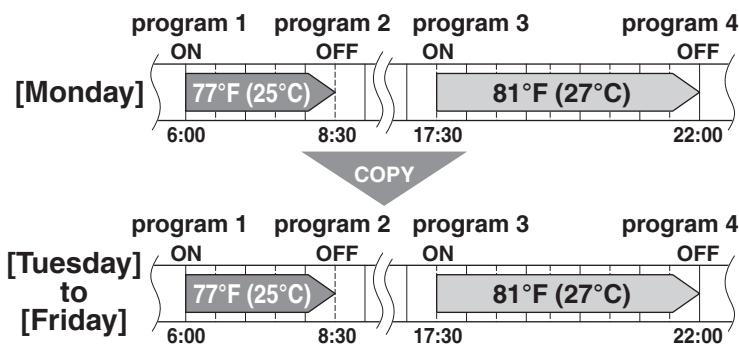

1. Press .
2. Press to confirm the day of the week to be copied.
3. Press .
  - The whole reservation of the selected day of the week will be copied.
4. Press to select the destination day of the week.
5. Press .
  - Check for a receiving tone and that the OPERATION lamp blinks twice.
  - The reservation will be copied to the selected day of the week. The whole reservation of the selected day of the week will be copied.
  - To continue copying the settings to other days of the week, repeat **STEP 4** and **STEP 5**.
6. Press to complete the setting.
  - “ WEEKLY” is displayed on the LCD and WEEKLY TIMER operation is activated.

## NOTE

### Note on COPY MODE

- The entire reservation of the source day of the week is copied in the copy mode.  
In the case of making a reservation change for any day of the week individually after copying the content of weekly reservations, press and change the settings in the steps of **Setting mode** . **▶Page 22**



# WEEKLY TIMER Operation

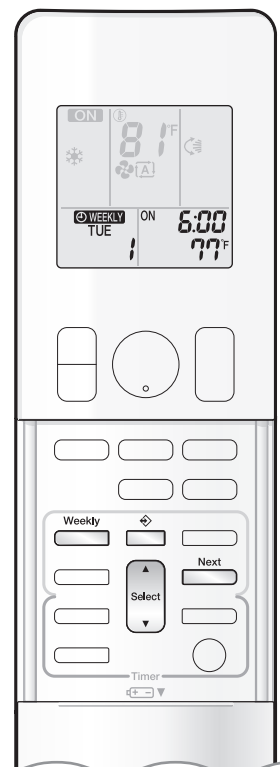

## Confirming a reservation

- The reservation can be confirmed.

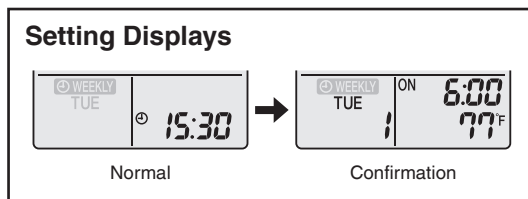

### 1. Press .

- The day of the week and the reservation number of the current day will be displayed.

### 2. Press to select the day of the week and the reservation number to be confirmed.

- Pressing displays the reservation details.
- To change the confirmed reserved settings, select the reservation number and press . The mode is switched to setting mode. Proceed to **Setting mode** STEP 4. [▶Page 22](#)

### 3. Press to exit the confirmation mode.

- “ ” is displayed on the LCD and WEEKLY TIMER operation is activated.

## To deactivate WEEKLY TIMER operation

### Press while “ ” is displayed on the LCD.

- “ ” disappears from the LCD.
- The TIMER lamp goes off.
- To reactivate the WEEKLY TIMER operation, press again.
- If a reservation deactivated with is activated once again, the last reservation mode will be used.

## NOTE

- If not all the reservation settings are reflected, deactivate the WEEKLY TIMER operation once. Then press again to reactivate the WEEKLY TIMER operation.

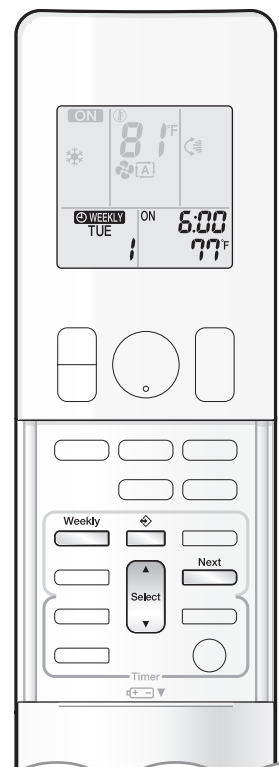

## To delete reservations

### An individual reservation

**1. Press** .

- The day of the week and the reservation number will be displayed.

**2. Press** **to select the day of the week and the reservation number to be deleted.**

**3. Press** .

- “ WEEKLY” and “ON” or “OFF” blink.

**4. Press** **until no icon is displayed.**

- Pressing changes the ON/OFF TIMER mode in sequence.
- Selecting “blank” will cancel any reservation you may have.



**5. Press** .

- Check for a receiving tone and that the OPERATION lamp blinks twice.
- The selected reservation will be deleted.

**6. Press** .

- If there are still other reservations, WEEKLY TIMER operation will be activated.

### Reservations for each day of the week

- This function can be used for deleting reservations for each day of the week.
- It can be used while confirming or setting reservations.

**1. Press** .

- The day of the week and the reservation number will be displayed.

**2. Press** **to select the day of the week to be deleted.**

**3. Hold** **for about 5 seconds.**

- Check for a receiving tone and that the OPERATION lamp blinks twice.
- The reservation of the selected day of the week will be deleted.

**4. Press** .

- If there are still other reservations, WEEKLY TIMER operation will be activated.

### All reservations

**Hold** **for about 5 seconds with the normal display.**

- Check for a receiving tone and that the OPERATION lamp blinks twice.
- “ WEEKLY” disappears from the LCD.
- The TIMER lamp goes off.
- All reservations will be deleted.
- This operation is not functional while the WEEKLY TIMER setting screen is displayed.

# Care and Cleaning

## ⚠ CAUTION

- Before cleaning, be sure to stop the operation and turn off the circuit breaker.
- Do not touch the aluminum fins of the indoor unit. If you touch those parts, this may cause an injury.

## ■ Quick reference

### Cleaning parts

#### Front panel

- Wipe it with a soft damp cloth.

**If dirty** ▶Page 28

#### Air filter

- Vacuum dust or wash the filter.

**Once every 2 weeks**

▶Page 29

#### Titanium apatite photocatalytic air-purifying filter

- Vacuum dust or replace the filter.

[Cleaning]

**Once every 6 months**

▶Page 30

[Replacement]

**Once every 3 years**

▶Page 30

#### Indoor unit and remote controller

- Wipe them with a soft cloth.

**If dirty**

### Notes on cleaning

For cleaning, do not use any of the following:

- Water hotter than 104°F (40°C)
- Volatile liquid such as benzine, gasoline and thinner
- Polishing compounds
- Rough materials such as a scrubbing brush

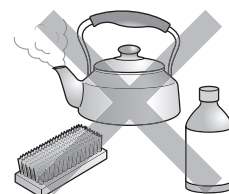

## CAUTION

- When removing or attaching the front panel, stand on a solid, stable base and take care not to fall.
- When removing or attaching the front panel, support the panel securely with your hand to prevent it from falling.

### ■ Front panel

#### 1. Open the front panel.

- Grip the panel tabs on each side of the front panel and open.

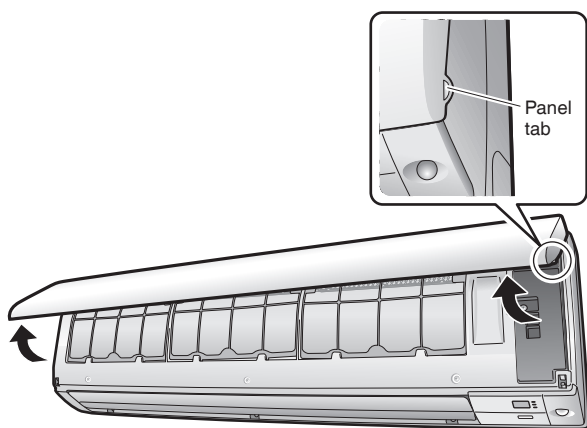

#### 2. Remove the front panel.

- 1) Slide the front panel to either the left or right and pull it toward you to disengage one of the front panel shafts.

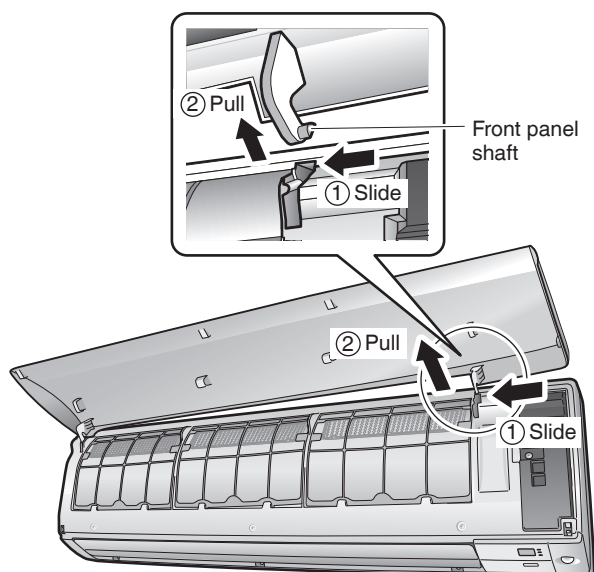

- 2) Disengage the front panel shaft on the other side in the same manner.
- 3) After disengaging both front panel shafts, pull the front panel toward yourself and remove it.

#### 3. Clean the front panel.

- Wipe it with a soft damp cloth.
- Only neutral detergent may be used.
- In case of washing the panel with water, wipe it with a dry soft cloth, and let it dry in the shade after washing.

#### 4. Attach the front panel.

- Align the front panel shaft on the left and right of the front panel with the grooves, then push them all the way in.

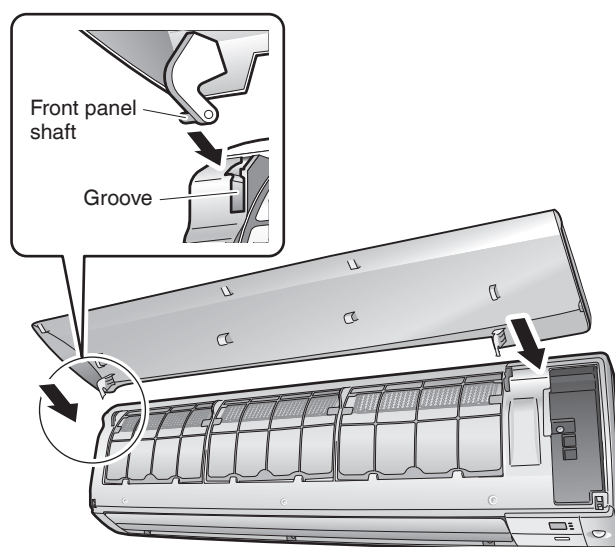

#### 5. Close the front panel slowly.

- Press the front panel at both sides and in the central area.

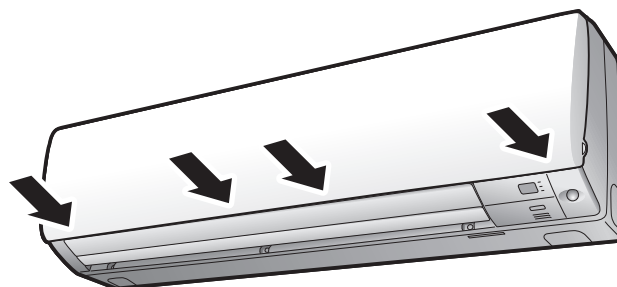

- Make sure that the front panel is securely fixed.

# Care and Cleaning

## ■ Air filter

**1. Open the front panel.** ▶ Page 28

**2. Pull out the air filters.**

- Push the filter tab at the center of each air filter a little upwards, then pull it down.

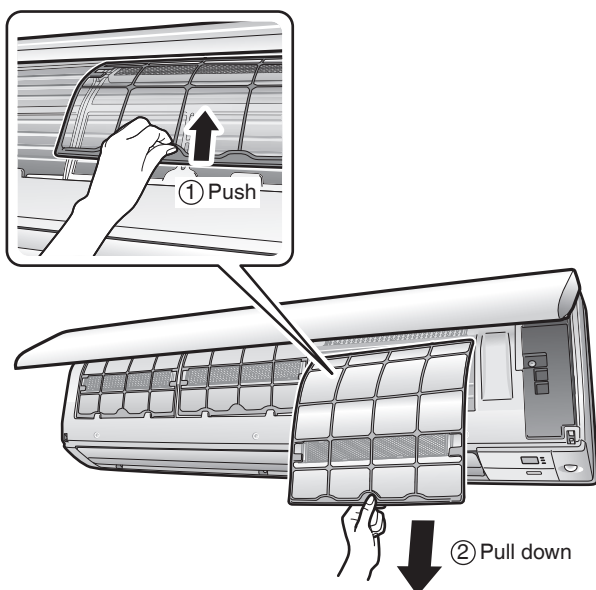

**3. Wash the air filters with water or clean them with a vacuum cleaner.**

- It is recommended to clean the air filters every 2 weeks.

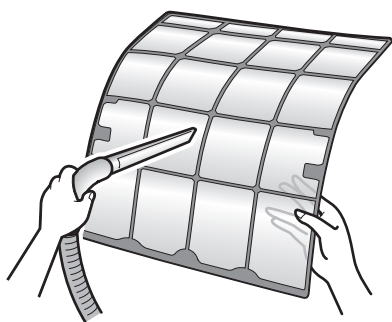

### If the dust does not come off easily

- Wash the air filters with neutral detergent thinned with lukewarm water, then let them dry in the shade.
- Be sure to remove the titanium apatite photocatalytic air-purifying filter. Refer to “**Titanium apatite photocatalytic air-purifying filter**” on the next page.



**4. Set the filters as they were.**

**5. Close the front panel slowly.**

▶ Page 28

## ■ Titanium apatite photocatalytic air-purifying filter

**1. Open the front panel and pull out the air filters.** ▶Page 28,29

**2. Take off the titanium apatite photocatalytic air-purifying filters.**

- Hold the recessed parts of the frame and unhook the 4 claws.

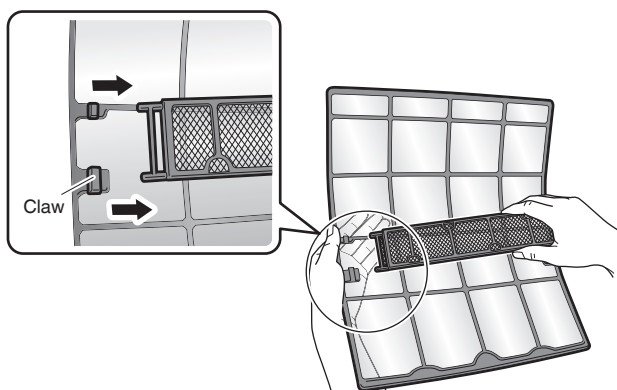

**3. Clean or replace the titanium apatite photocatalytic air-purifying filters.**

### [Cleaning]

**3-1 Vacuum dust, and soak in lukewarm water or water for about 10 to 15 minutes if very dirty.**

- Do not remove the filter from the frame when washing with water.

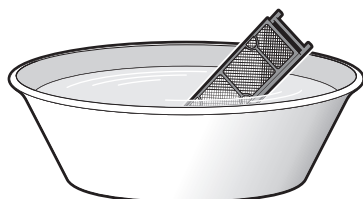

**3-2 After washing, shake off remaining water and let them dry in the shade.**

- Do not wring out the filter to remove water from it.

### [Replacement]

**Remove the filter from the filter frame and attach a new one.**

- Do not throw away the filter frame. Reuse the filter frame when replacing the titanium apatite photocatalytic air-purifying filter.
- When attaching the filter, check that the filter is properly set in the tabs.

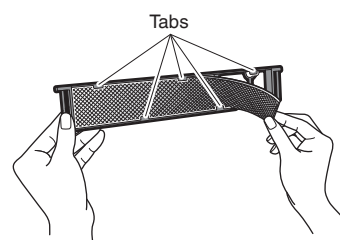

- Dispose of the old filter as non-flammable waste.

**4. Set the titanium apatite photocatalytic air-purifying filters as they were.**

**5. Set the air filters as they were.** ▶Page 29

**6. Close the front panel slowly.** ▶Page 28

### NOTE

- Operation with dirty filters:
  - cannot deodorize the air,
  - cannot clean the air,
  - results in poor heating or cooling,
  - may cause odor.
- Dispose of old filters as non-flammable waste.
- To order a titanium apatite photocatalytic air-purifying filter, contact the dealer where you bought the air conditioner.

Item	Titanium apatite photocatalytic air-purifying filter (set of 3)
Part No.	KAF970A48 (without frame)





# Care and Cleaning

---

## ■ Prior to a long period of non-use

### **1. Operate the FAN mode for several hours to dry out the inside.**

- 1) Press  and select “”.
- 2) Press  and start the operation.

### **2. After operation stops, turn off the circuit breaker for the room air conditioner.**

### **3. Clean the air filters and reattach them.**

### **4. To prevent battery leakage, take out the batteries from the remote controller.**

## ■ We recommend periodical maintenance

- In certain operating conditions, the inside of the air conditioner may get foul after several seasons of use, resulting in poor performance. It is recommended to have periodical maintenance by a qualified contractor in addition to regular cleaning by the user.
- For qualified contractor maintenance, please contact the dealer where you bought the air conditioner.

# FAQ

## Indoor unit

### The flaps do not start swinging immediately.

- The air conditioner is adjusting the position of the flaps. The flaps will start moving soon.

### The air conditioner stops generating airflow during HEAT operation.

- Once the set temperature is reached, the airflow rate is reduced and operation stopped in order to avoid generating a cool airflow. Operation will resume automatically when the indoor temperature falls.

### HEAT operation stops suddenly and a flowing sound is heard.

- The outdoor unit is defrosting. HEAT operation starts after the frost on the outdoor unit has been removed. This can take about 4 to 12 minutes.

### Operation does not start soon.

- **When the unit is turned on again soon after being turned off.**
- **When the mode was reselected.**
  - This is to protect the air conditioner. You should wait for about 3 minutes.
- **For COOLING ONLY models (outdoor unit: RK models) using facility settings**
  - For the purposes of protecting the compressor, it can take up to 3 hours for operation to begin after the unit is turned on.

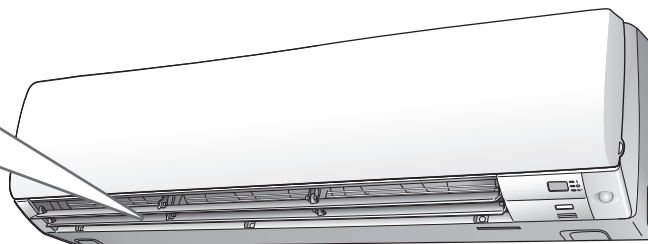

### Different sounds are heard.

- **A sound like flowing water**
  - This sound is generated because the refrigerant in the air conditioner is flowing.
  - This is a pumping sound of the water in the air conditioner and can be heard when the water is pumped out from the air conditioner during COOL or DRY operation.
- **Blowing sound**
  - This sound is generated when the flow of the refrigerant in the air conditioner is switched over.
- **Ticking sound**
  - This sound is generated when the cabinet and frame of the air conditioner slightly expand or shrink as a result of temperature changes.
- **Whistling sound**
  - This sound is generated when refrigerant flows during defrosting operation.
- **Clicking sound during operation or idle time**
  - This sound is generated when the refrigerant control valves or the electrical parts operate.
- **Clopping sound**
  - This sound is heard from the inside of the air conditioner when the exhaust fan is activated while the room doors are closed. Open the window or turn off the exhaust fan.

## Outdoor unit

### Operating sound is loud.

- When frost forms on the heat exchanger of the outdoor unit, the operating sound level increases slightly.

### The outdoor unit emits water or steam.

- **In HEAT operation**
  - The frost on the outdoor unit melts into water or steam when the air conditioner is in defrosting operation.
- **In COOL or DRY operation**
  - Moisture in the air condenses into water on the cool surface of the outdoor unit piping and drips.

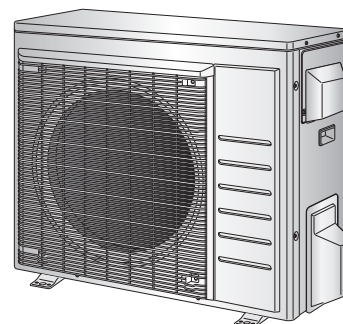

# Troubleshooting

Before making an inquiry or a request for repair, please check the following.  
If the problem persists, consult your dealer.



## Not a problem

This case is not a problem.



## Check

Please check again before requesting repairs.

### The air conditioner does not operate

Case	Description / what to check
OPERATION lamp is off.	<ul style="list-style-type: none"> <li>Has the circuit breaker been tripped or the fuse blown?</li> <li>Is there a power failure?</li> <li>Are batteries set in the remote controller?</li> </ul>
OPERATION lamp is blinking.	<ul style="list-style-type: none"> <li>Turn off the power with the circuit breaker and restart operation with the remote controller. If the OPERATION lamp is still blinking, check the error code and consult your dealer.</li> </ul>

▶ Page 36

### The air conditioner suddenly stops operating

Case	Description / what to check
OPERATION lamp is on.	<ul style="list-style-type: none"> <li>To protect the system, the air conditioner may stop operating after sudden large voltage fluctuations. It automatically resumes operation in about 3 minutes.</li> </ul>
OPERATION lamp is blinking.	<ul style="list-style-type: none"> <li>Are the air filters dirty? Clean the air filters.</li> <li>Is there anything blocking the air inlet or air outlet of the indoor unit or outdoor unit? Stop operation and after turning off the circuit breaker, remove the obstruction. Then restart operation with the remote controller. If the OPERATION lamp is still blinking, check the error code and consult your dealer.</li> </ul>

▶ Page 36

### The air conditioner does not stop operating

Case	Description / what to check
The air conditioner continues operating even after operation is stopped.	<ul style="list-style-type: none"> <li><b>Immediately after the air conditioner is stopped</b> <ul style="list-style-type: none"> <li>The outdoor unit fan continues rotating for about another 1 minute to protect the system.</li> </ul> </li> <li><b>While the air conditioner is not in operation</b> <ul style="list-style-type: none"> <li>When the outdoor temperature is high, the outdoor unit fan may start rotating to protect the system.</li> </ul> </li> </ul>

### The room does not cool down / warm up

Case	Description / what to check
Air does not come out.	<ul style="list-style-type: none"> <li><b>In HEAT operation</b> <ul style="list-style-type: none"> <li>The air conditioner is warming up. Wait for about 1 to 4 minutes.</li> <li>During defrosting operation, hot air does not flow out of the indoor unit.</li> </ul> </li> <li><b>When the air conditioner operates immediately after the circuit breaker is turned on</b> <ul style="list-style-type: none"> <li>The air conditioner is preparing to operate. Wait for about 3 to 10 minutes.</li> </ul> </li> </ul>
Air does not come out / Air comes out.	<ul style="list-style-type: none"> <li><b>Is the airflow rate setting appropriate?</b> <ul style="list-style-type: none"> <li>Is the airflow rate setting low, such as "Indoor unit quiet" or "Airflow rate 1"? Increase the airflow rate setting.</li> </ul> </li> <li><b>Is the set temperature appropriate?</b></li> <li><b>Is the adjustment of the airflow direction appropriate?</b></li> </ul>
Air comes out.	<ul style="list-style-type: none"> <li>Is there any furniture directly under or beside the indoor unit?</li> <li>Is the air conditioner in ECONO operation or OUTDOOR UNIT QUIET operation?</li> <li>Is the air filter dirty?</li> <li>Is there anything blocking the air inlet or air outlet of the indoor unit or outdoor unit?</li> <li>Is a window or door open?</li> <li>Is an exhaust fan turning?</li> </ul>

▶ Page 18

## Mist comes out

Case	Description / what to check
Mist comes out of the indoor unit.	<input checked="" type="checkbox"/> • This happens when the air in the room is cooled into mist by the cold airflow during COOL or other operation.

## Remote controller

Case	Description / what to check
The unit does not receive signals from the remote controller or has a limited operating range.	<input checked="" type="checkbox"/> • The batteries may be exhausted. Replace both batteries with new dry batteries AAA.LR03 (alkaline). For details, refer to “ <b>Preparation Before Operation</b> ”. ▶Page 9 <input checked="" type="checkbox"/> • Signal communication may be disabled if an electronic-starter-type fluorescent lamp (such as inverter-type lamps) is in the room. Consult your dealer if that is the case. <input checked="" type="checkbox"/> • The remote controller may not function correctly if the transmitter is exposed to direct sunlight.
LCD is faint, is not working, or the display is erratic.	<input checked="" type="checkbox"/> • The batteries may be exhausted. Replace both batteries with new dry batteries AAA.LR03 (alkaline). For details, refer to “ <b>Preparation Before Operation</b> ”. ▶Page 9
Other electric devices start operating.	<input checked="" type="checkbox"/> • If the remote controller activates other electric devices, move them away or consult your dealer.

## Air has an odor

Case	Description / what to check
The air conditioner gives off an odor.	<input checked="" type="checkbox"/> • The room odor absorbed in the unit is discharged with the airflow. We recommend you to have the indoor unit cleaned. Please consult your dealer.

## Others

Case	Description / what to check
The air conditioner suddenly starts behaving strangely during operation.	<input type="checkbox"/> • The air conditioner may malfunction due to lightning or radio. If the air conditioner malfunctions, turn off the power with the circuit breaker and restart the operation with the remote controller.
HEAT operation cannot be selected, even though the unit is heat pump model.	<input type="checkbox"/> • Check that the jumper (J8) has not been cut. If it has been cut, contact your dealer.
The ON/OFF TIMER does not operate according to the settings.	<input checked="" type="checkbox"/> • Check if the ON/OFF TIMER and the WEEKLY TIMER are set to the same time. Change or deactivate the settings in the WEEKLY TIMER. ▶Page 21



## Notes on the operating conditions

- If operation continues under any conditions other than those listed in the table,
  - A safety device may activate to stop the operation.
  - Dew may form on the indoor unit and drip from it when COOL or DRY operation is selected.

Mode	Operating conditions
COOL / DRY	Outdoor temperature: 50-115°F (10-46°C) Indoor temperature: 64-90°F (18-32°C) Indoor humidity: 80% max.
HEAT	Outdoor temperature: 5-75°F (–15-24°C) Indoor temperature: 50-86°F (10-30°C)

# Troubleshooting

## ■ Call your dealer immediately

### WARNING

**When an abnormality (such as a burning smell) occurs, stop operation and turn off the circuit breaker.**

- Continued operation in an abnormal condition may result in problems, electric shock or fire.
- Consult the dealer where you bought the air conditioner.

**Do not attempt to repair or modify the air conditioner by yourself.**

- Incorrect work may result in electric shock or fire.
- Consult the dealer where you bought the air conditioner.

**If one of the following symptoms takes place, call your dealer immediately.**

- The power cord is abnormally hot or damaged.
- An abnormal sound is heard during operation.
- The circuit breaker, a fuse, or the GFCI cuts off the operation frequently.
- A switch or a button often fails to work properly.
- There is a burning smell.
- Water leaks from the indoor unit.

Turn off the circuit breaker and call your dealer.



### ■ After a power failure

- The air conditioner automatically resumes operation in about 3 minutes. Please wait for a while.

### ■ Lightning

- If there is a risk lightning could strike in the neighborhood, stop operation and turn off the circuit breaker to protect the system.

## ■ Disposal requirements

- Dismantling of the unit, handling of the refrigerant, oil and other parts, should be done in accordance with the relevant local and national regulations.

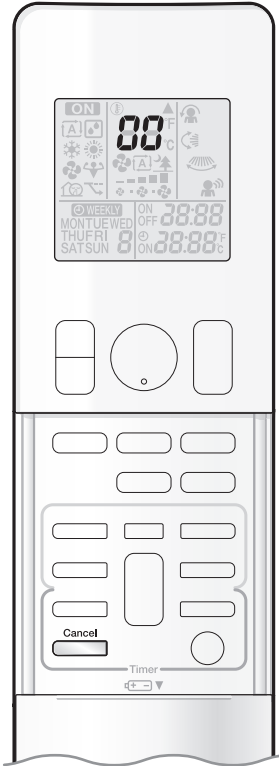

## ■ Fault diagnosis by remote controller

- The remote controller can receive relevant error codes from the indoor unit.

**1.** When  is held down for about 5 seconds, “00” blinks in the temperature display section.

**2.** Press  repeatedly until a long beep is produced.

- The code indication changes as shown below, and notifies you with a long beep.

	CODE	MEANING
SYSTEM	00	NORMAL
	U0	REFRIGERANT SHORTAGE
	U2	OVER-VOLTAGE DETECTION
	U4	SIGNAL TRANSMISSION ERROR (BETWEEN INDOOR AND OUTDOOR UNIT)
INDOOR UNIT	A1	INDOOR UNIT PCB ABNORMALITY
	A5	FREEZE-UP PROTECTION OR HEATING PEAK-CUT CONTROL
	A6	FAN MOTOR (DC MOTOR) ABNORMALITY
	C4	INDOOR HEAT EXCHANGER THERMISTOR ABNORMALITY
	C9	ROOM TEMPERATURE THERMISTOR ABNORMALITY
OUTDOOR UNIT	EA	FOUR WAY VALVE ABNORMALITY
	E1	OUTDOOR UNIT PCB ABNORMALITY
	E5	OL ACTIVATION (COMPRESSOR OVERLOAD)
	E6	COMPRESSOR LOCK
	E7	DC FAN LOCK
	F3	DISCHARGE PIPE TEMPERATURE CONTROL
	H0	COMPRESSOR SYSTEM SENSOR ABNORMALITY
	H6	POSITION SENSOR ABNORMALITY
	H8	DC VOLTAGE / CURRENT SENSOR ABNORMALITY
	H9	OUTDOOR TEMPERATURE THERMISTOR ABNORMALITY
	J3	DISCHARGE PIPE THERMISTOR ABNORMALITY
	J6	OUTDOOR HEAT EXCHANGER THERMISTOR ABNORMALITY
	L4	RADIATION FIN TEMPERATURE RISE
L5	OUTPUT OVERCURRENT DETECTION	
P4	RADIATION FIN THERMISTOR ABNORMALITY	

## NOTE

- A short beep and 2 consecutive beeps indicate non-corresponding codes.
- To cancel the code display, hold  down for about 5 seconds. The code display also clears if no button is pressed for 1 minute.

# Quick Reference

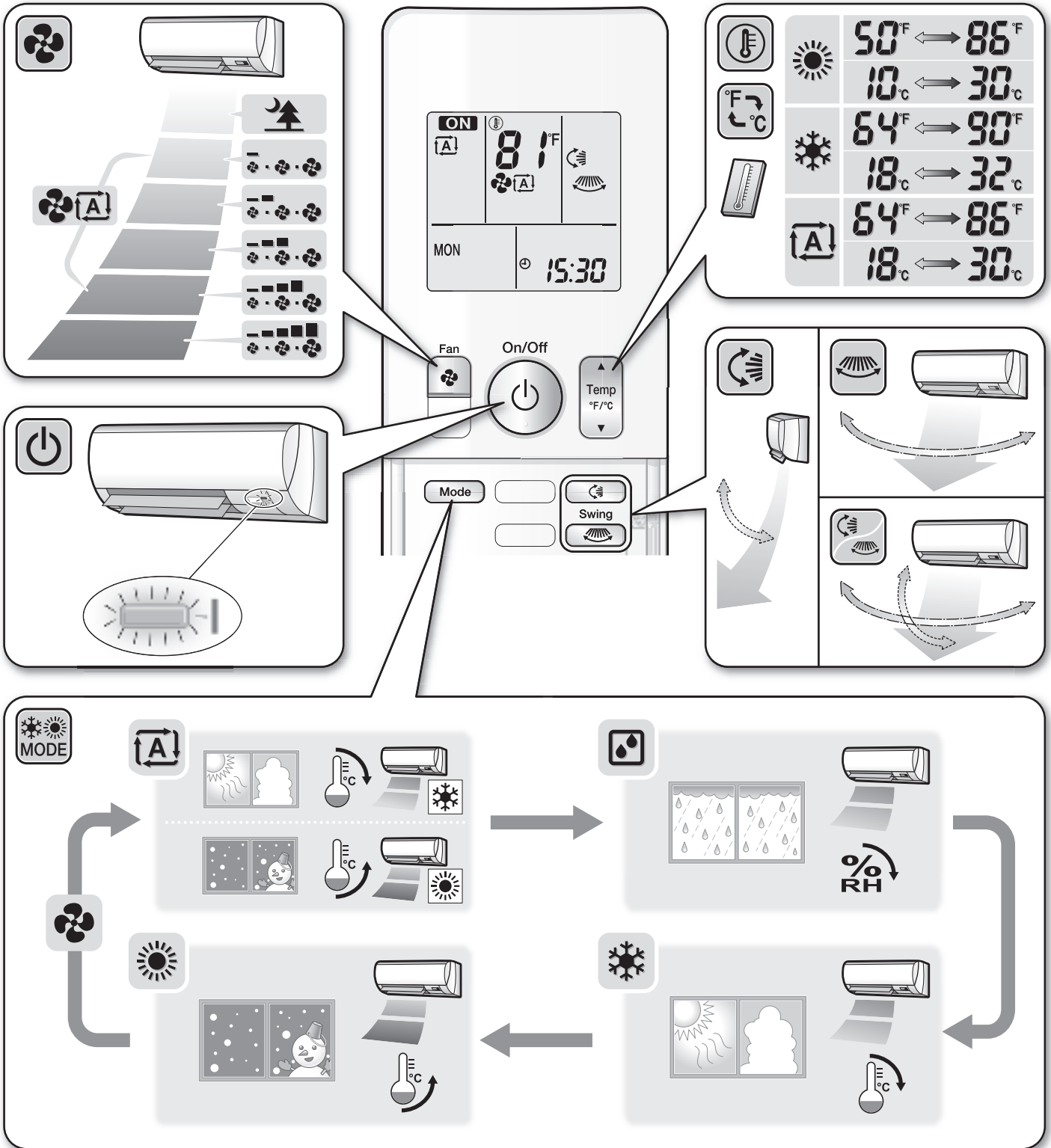

## GOODMAN MANUFACTURING COMPANY, L.P.

5151 San Felipe, Suite 500  
Houston, TX 77056 USA

## DAIKIN INDUSTRIES, LTD.

Head office:  
Umeda Center Bldg., 2-4-12, Nakazaki-Nishi,  
Kita-ku, Osaka, 530-8323 Japan

Tokyo office:  
JR Shinagawa East Bldg., 2-18-1, Konan,  
Minato-ku, Tokyo, 108-0075 Japan  
<http://www.daikin.com>



The two-dimensional bar code is a manufacturing code.

3P457796-1 M16B116 (1611)HT